



BOSCH



THE BEST
YOUR TOOL
CAN GET.

BOSCH PROFESSIONAL
ACCESSORIES



Price List 2021 / 2022

1st Edition April 2021





Description

Page

Complete Tools

EC Brushless Motor	4 - 5
Cordless Freedom Concept	6 - 9
Drill, Impact Drill, Cordless 3.6 V Li-Ion, 12 V Li-Ion	10
Cordless Tools 14.4 V Li-Ion, 18 V Li-Ion, 36 V Li-Ion, Multi-Cutter	11
SDS Plus Rotary Hammer, SDS Max Rotary Hammer, Demolition Hammer	12
Straight Grinder, Small Angle Grinder, Large Angle Grinder	13
Impact Wrench, Stirrer / Mixer Drill, Bench Grinder, Shear / Nibbler, Concrete Cutter, Reciprocating Saw	14
Jigsaw, Circular Saw, Bench Top, Foam Rubber Cutter, Planer	15
Orbital Sander, Belt Sander, Multi Sander, Polisher, Blower, Mini Router/Trimmer, Hot Air Gun	16
Vacuum Cleaner, Measuring Tools - Range Finder, Detector, Leveler, Cordless Inspection Camera, Cordless Thermo Detector	17
Angle Measurer, Digital Inclinometer, Receiver, Stand, Measuring Rail, Rod, Telescopic Pole	18

Home & Garden

High Pressure Cleaner (Suitable for Industrial Use), High Pressure Cleaner (Suitable for Home Use)	19
High Pressure Cleaner Accessories	20

Accessories

Miscellaneous, Straight Shank Drill Bit - Ceramic Expert Drill Bit, Flat Wood Bit, Cobalt Drill Bit	21
Straight Shank Drill Bit - Cylindrical Shank Drill Bit CYL-5, CYL-2 Concrete Drill Bit	22
HSS-G Set, 1/4" Hex Shank HSS-G Metal Drill Bit, HSS-G Cobalt 135° Metal Drill Bit	23
HSS-PointTeQ Metal Drill Bit	24 - 26
Sanding & Polishing for Drill, De-rusting Accessories for Drill, Shaping Accessories for Drill, Screwdriver Bit	27
Battery Tool Accessories	28
NEW! 125 mm X-LOCK Accessories	29
Angle Grinder & Cut Off Machine Accessories - Grinding Disc, Cutting Disc, Accessories for GWS 12-76 V-EC, Rubber Pad	30
Diamond Cutting Disc - Diamond Blade for Grinder & Concrete Cutter, Flap Disc, Zirconia Flap Disc (Standard for Inox)	31
Nibbler Accessories, Foam Rubber Cutter Accessories, Jigsaw Accessories	32

Description	Page
Accessories	
Jigsaw Accessories	33 - 35
Sabresaw Blade, Reciprocating Saw Blade	36 - 37
Router Accessories, Circular Saw Accessories - For GKS 6 1/2", GKS 7 1/4", GKS 165, GKS 190 & GKS 235, Circular Saw Balde (Wood Cutting), Circular Saw Blade Eco Range, Multi Material Circular Saw Blade	38 - 39
Vacuum Cleaner Accessories, Glue Gun Accessories	40
Hot Air Gun Accessories, Bench Grinder Accessories	41
Belt Sander Accessories	42
NEW! TCT Annular Cutter	43
Multi Sander Accessories	44 - 45
HSS Bi-Metal Holesaw	46
TCT Holesaw, Planer Accessories, Mini Router / Trimmer Accessories	47
SDS Plus Drill Bit - SDS Plus Drill Bit (Plus 1)	48
SDS Plus Drill Bit (Plus 5X)	49 - 50
SDS Plus Chisel	51
CYL-2 Concrete Drill Bit	52
SDS Max-2 Cutter Drill Bit	53
SDS Max M4 Drill Bit	54
SDS Max Speed X Drill Bit	55 - 56
SDS Max 8X Drill Bit	57
SDS Max Breakthrough Drill Bit, SDS Max Core Cutter	58
SDS Max Chisel, SDS Max Adapter	59
Chisel - For Model USH 27 & GSH 27, GSH 16-30, Hex 17 mm Chisel	60
Rotary Hammer Accessories	61
Cordless Multi-Cutter Accessories	62 - 63
Spare Parts Peice List	64 - 72

BUILT FOR CHAMPS

EC Brushless Motor

2X LIFETIME



Up to 30% MORE RUNTIME

*Compared to Bosch power tools with DC motor of same class

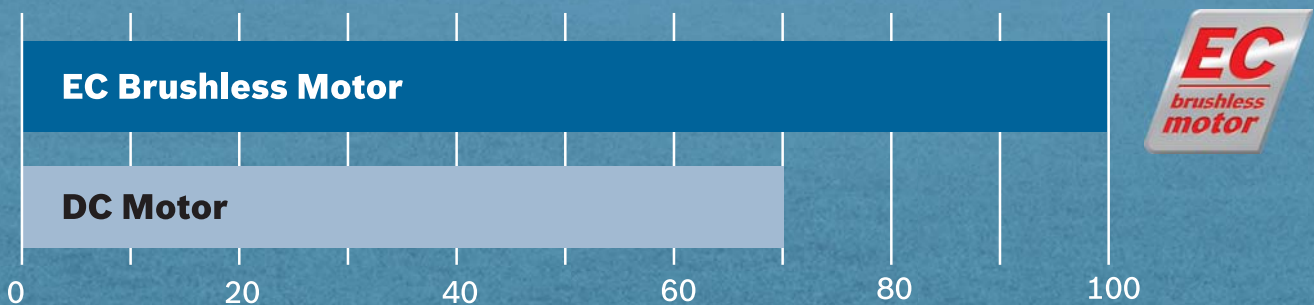

How it works



EC Brushless Motor

No brush sparking due to electrical switch by electronics.



DC Motor

Brush sparking at every mechanical switch operation

Forward: Endless runner.

Bosch EC Brushless Motor range

Cordless Rotary Hammer
GBH 36 V-EC Compact Professional



Cordless Impact Driver
GDR 12 V-EC Professional



Cordless Rotary Hammer
GBH 18 V-EC Professional



Cordless Impact Driver
GDS 12 V-EC Professional

Cordless Impact Drill
GSR 18 V-EC Professional



Our Hero!
Impact Wrench Driver
GDx 18 V-EC Professional



Longer runtime
Longer lifetime



Cordless Drill/Screwdriver
GSR 12 V-EC Professional

Cordless Impact Drill / Driver
GSB 18 V-EC Professional



Cordless Multi-Cutter
GOP 18 V-EC Professional



Cordless Impact Driver
GDS 18 V-EC Professional



The Freedom Concept

The freedom concept provides the freedom to choose cordless tools, batteries, chargers, and carrying cases exactly according to your needs. You are now free to choose.



Bosch Lithium-Ion Cordless Tools Range

3,6 Volt	10,8 Volt	14,4 Volt
pocketseries	compactseries	lightseries
 <p>GSR ProDrive</p> <p>The World's smallest professional screwdriver</p>  <p>Bosch Go</p> <p>Ready as ever. Better than ever</p>	 <p>GAS 10.8 V-LI</p>  <p>GKS 10.8 V-LI</p>  <p>GST 10.8 V-LI</p>  <p>GUS 10.8 V-LI</p>  <p>GSR 1080-2-LI Set</p>  <p>GSR 10.8 V-EC Set</p>  <p>GWB 10.8 V-LI Set</p>  <p>GSA 10.8 V-LI Set</p>  <p>GSB 1080-2-LI Set</p>  <p>GDR 10.8 V-EC Set</p>  <p>GWI 10.8 V-LI Set</p>  <p>GOP 10.8 V-LI Set</p> <p>Extremely compact</p>	 <p>GDR 1440-LI Set</p>  <p>GSR 1440-LI Set</p>  <p>GSR 14.4-2-LI Set</p>  <p>GSB 14.4-2-LI Set</p> <p>Extremely lightweight</p>
Battery Pack	 <p>1.5 Ah</p>  <p>2.0 Ah</p>	 <p>1.5 Ah</p>  <p>2.0 Ah</p> 
Charger	 <p>AL 1130 CV</p>	 <p>AL 1860 CV</p>
Starter Kit	 <p>AL 1130 CV + 2 Battery Packs (2.0 Ah 10.8V)</p>	 <p>AL 1860 CV + 2 Battery Packs</p>
L-BOXX	 <p>L-BOXX 102</p>	 <p>L-BOXX 136</p>

NEW! INNOVATIVE BOSCH CORDLESS TECHNOLOGY



Kick Back Stop detects sudden movements and stop tool rotation



ETP protects your tool from Rain & Dust

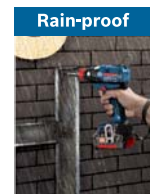

CHOOSE YOUR OWN COMBINATION



BARE TOOLS

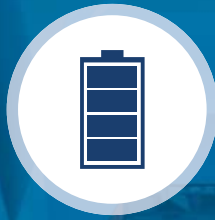

BATTERIES

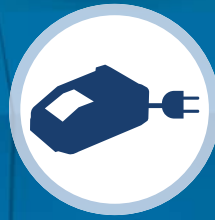

CHARGERS



L-BOXX

	18 Volt			36 Volt superseries
robustseries	lightseries	robustseries		
 GDR 14.4 V-LI	 GSR 1800-LI Set	 GDS 18 V-LI HT	 GDV 18 V-LI	 GDS 18 V-LI Set
	 GBH 18 V-EC Set	 GBH 36 V-LI Plus		
	 GSB 18-2-LI Set	 GWS 18 V-LI	 GGS 18 V-LI	 GSS 18 V-LI
	 GKS 18 V-LI	 GST 18 V-LI	 GAS 18 V-1 LI	 GBH 36 V-LI Compact Set
Extremely robust	Extremely lightweight	Extremely robust		As powerful as corded
 4.0 Ah	 2.0 Ah	 4.0 Ah	 6.0 Ah	 2.0 Ah
		 AL 1860 CV		 AL 3640 CV
 (2.0 Ah 14.4V)	 AL 1860 CV + 2 Batteries (2.0 Ah 18V)	 AL 1860 CV + 2 Batteries (4.0 Ah 18V)	 AL 1860 CV + 2 Batteries (5.0 Ah 18V)	
	 L-BOXX 102	 L-BOXX 136	 L-BOXX 238	 L-BOXX 306
			 L-BOXX 374	



EMP protects the motor against overload and automatically shuts it down in case of stalling



2 X Lifetime
up to 30% more runtime



ECP prevents your battery from deep discharge, overheating, overload



EC Brushless Motor
No brush sparking due to electrical switch by electronics

DC Motor
Brush sparking at every mechanical switch operation



Bosch Lithium-Ion Cordless Tools Range - The **Freedom** Concept



BOSCH

Invented for life

1

Cordless Freedom Concept

Bare Unit

Status	Model	Part Number	Description	List Price (SGD)
	GWS 12-76 V-EC	0 601 9F2 000	Cordless Angle Grinder	276.00
	GAS 12 V-LI	0 601 9E3 081	Cordless Vacuum Cleaner	148.00
	GKS 12 V-LI	0 601 6A1 0L2	Cordless Circular Saw	170.00
	GSA 12 V-LI	0 601 9E3 081	Cordless Sabre Saw	276.00
	GST 12 V-LI	0 601 5A1 0L1	Cordless Jigsaw	260.00
	GWI 12 V-LI	0 601 360 UL1	Cordless Angle Driver	330.00
	GSB 14.4-2-LI	0 601 9C7 0B2	Cordless Impact Drill	198.00
	GBL 18 V-120	0 601 9F5 1L0	Cordless Blower	170.00
	GDS 18 V-LI HT	0 601 9A1 3B8	Cordless Impact Wrench	1,344.00
	GDX 18 V-LI	0 601 9B8 1B1	Cordless Impact Driver/Wrench	382.00
	GKS 18 V-LI	0 601 66H 0B0	Cordless Circular Saw	660.00
	GOP 18 V-EC	0 601 8B0 0B0	Cordless Multi Cutter	472.00
	GSB 18-2-LI	0 601 9D2 3B2	Cordless Impact Drill	218.00
	GSB 18 V-EC	0 601 9D7 100	Cordless Impact Drill / Driver	366.00
	GSR 18 V-EC	0 601 9D6 100	Cordless Impact Drill	340.00
	GSS 18 V-LI	0 601 9D0 2L0	Orbital Sander	168.00
	GST 18 V-LI	0 601 58J 302	Cordless Jigsaw	532.00
	GWS 18 V-LI	0 601 93A 3B0	Cordless Angle Grinder	390.00
	GGG 18 V-LI	0 601 9B5 300	Cordless Straight Grinder	480.00
	GAS 18 V-LI	0 601 9C6 1L0	Cordless Vacuum Cleaner	154.00



Battery Pack

Status	Model	Part Number	List Price (SGD)
	Battery Pack 2.0Ah 12V	1 600 A00 F6X	66.00
	Battery Pack 2.5Ah 12V	1 600 A00 F70	90.00
	Battery Pack 1.5Ah 14.4V	1 600 A00 1C1	80.00
	Battery Pack 2.0Ah 14.4V	1 600 A00 1C5	112.00
	Battery Pack 4.0Ah 14.4V	1 600 A00 162	170.00
	Battery Pack 1.5Ah 18V	1 600 A00 1CC	94.00
	Battery Pack 2.0Ah 18V	1 600 A00 1CG	128.00
	Battery Pack 4.0Ah 18V	1 600 A00 163	192.00
	Battery Pack 5.0Ah 18V	1 600 A00 1Z9	262.00
	Battery Pack 6.0Ah 18V	1 600 A00 4ZN	268.00
	Battery Pack (ProCore 18V 4.0Ah)	1 600 A01 6GB	215.00
	Battery Pack (ProCore 18V 8.0Ah)	1 600 A01 6GK	310.00
	Battery Pack 2.0Ah 36V	1 600 A00 1ZJ	292.00
	Battery Pack 4.0Ah 36V	1 600 A00 12N	420.00



Bosch Lithium-Ion Cordless Tools Range - The **Freedom** Concept



BOSCH
Invented for life

1

Cordless Freedom Concept

Charger

Status	Model	Part Number	List Price (SGD)
	GAL 1240 CV (For 12 V)	1 600 A01 B8Z	56.00
	GAL 1860 CV (For 10.8 V to 18 V)	1 600 A00 16Y	88.00



L-BOXX

L-BOXX 102	1 600 A01 2FZ	78.00
L-BOXX 136	1 600 A01 2G0	82.00
L-BOXX 238	1 600 A01 2G2	102.00
L-BOXX 374	1 600 A01 2G3	136.00



Starter Kit

Starter Kit (1 Charger + 2 Batteries) 2.0Ah 12 V-LI	1 600 A01 B8Y	186.00
Starter Kit (1 Charger + 2 Batteries) 2.0Ah 14.4V-LI	1 600 A00 1AG	300.00
Starter Kit (1 Charger + 2 Batteries) 2.0Ah 18V-LI	1 600 A00 1AZ	330.00
Starter Kit (1 Charger + 2 Batteries) 4.0Ah 18V-LI	1 600 A00 1B7	456.00
Starter Kit (1 Charger + 2 Batteries) 6.0Ah 18V-LI	1 600 A00 B8M	580.00
Starter Kit (1 Charger + 2 Batteries) ProCore 18V 4.0Ah	1 600 A01 6GG	490.00



Complete Set*

***Comes with 2 batteries and 1 charger**

Status	Model	Part Number	Battery Power	Battery Capacity	List Price (SGD)
	GBH 18 V-EC	0 601 904 0L2	18 V-LI	3.0 Ah	1,160.00
	GSB 18-2-LI	0 601 9D2 3L1	18 V-LI	2.0 Ah	514.00
	GDS 18 V-LI HT	0 601 9A1 37C	18 V-LI	2.0 Ah	1,776.00
	GDX 18 V-EC	0 601 9B9 1L0	18 V-LI	4.0 Ah	960.00



**BOSCH**

Invented for life

Drill

Model	Part Number	Power	Capacity	List Price (SGD)
GBM 10 RE	0 601 473 5L0	450 W	0 - 2600 rpm	136.00
GBM 10 RE* (110V)	0 601 473 5C0	450 W	0 - 2600 rpm	164.00
GBM 350	0 601 1A9 5L0	350 W	0 - 2800 rpm	88.00
GBM 13 RE	0 601 477 5L0	600 W	0 - 2600 rpm	200.00
GBM 13-2*	0 601 169 003	550 W	13 mm, 550 / 1000 rpm	366.00
GBM 13 HRE	0 601 049 603	550 W	13 mm, 0 - 550 rpm	510.00
GBM 16-2 RE*	0 601 120 503	900 W	16 mm, 0 - 520 / 0 - 1200 rpm	1,050.00
GBM 23-2 E*	0 601 121 603	1150 W	23/13 mm, Spindle collar dia. 43 mm	1,680.00
GBM 32-4 E*	0 601 130 203	1500 W	210 / 330 / 470 / 740 rpm	1,800.00

**Impact Drill**

GSB 10 RE	0 601 216 1L6	500 W	10 mm, 0 - 2600 rpm	150.00
GSB 10 RE (110V)	0 601 216 1C0	500 W	10 mm, 0 - 2600 rpm	170.00
GSB 13 RE	0601 227 1L1	600 W	13 mm, 0 - 2800 rpm	206.00
GSB 16 RE	0 601 228 1L1	701 W	16 mm, 0 - 3000 rpm	230.00
GSB 16 RE (110V)	0 601 228 1C0	701 W	16 mm, 0 - 3000 rpm	240.00
GSB 20-2	0 601 184 206	701 W	20 mm / 1000 / 3000 rpm	258.00
GSB 20-2 RE	0 601 1A2 1L0	701 W	20 mm, 650 / 2000 rpm	318.00
GSB 21-2 RCT	0 601 19C 700	700 W	1300W 22mm, 0 - 1000 / 3000 rpm	640.00
GSB 21-2 RE* (110V)	0 601 19C 560	700 W	1300W 22mm, 0 - 1000 / 3000 rpm	660.00

**Cordless 3.6 V Li-Ion**

Bosch Go 3.6 V	0 601 9H2 0L1	3.6 V / 1.5 Ah	5 mm, 0 - 360 rpm	76.00
GSR 3.6 V-LI ProDrive	0 601 9A2 0L1	3.6 V / 1.3 Ah	5 mm, 0 - 250 rpm	156.00

**Cordless 12 V Li-Ion**

GDR 12 V-EC	0 601 9E0 0L2	12 V / 2.0 Ah	110 Nm, 0 - 1200 / 2600 rpm, 0 - 2700 / 3100 bpm	430.00
GDR 12-LI	0 601 9A6 9L7	12 V / 2.0 Ah	105 Nm, 0 - 2600 rpm, 0 - 3100 bpm	360.00
GOP 12 V-LI	0 601 858 0L3	12 V / 2.0 Ah	5000 - 20000 rpm	570.00
GSB 120	0 601 9F3 0L3	12 V / 1.5 Ah	28 / 11 Nm, 0 - 430 / 1300 rpm	238.00
GSR 12 V-EC	0 601 9D4 0L2	12 V / 2.0 Ah	20 / 18 Nm, 0 - 400 / 1300 rpm	500.00
GSR 120-LI	0 601 9F7 0L0	12 V / 1.5 Ah	30 / 13 Nm, 0 - 380 / 1300 rpm	198.00
GSR 12-2-LI	0 601 868 1LA	12 V / 2.0 Ah	30 Nm, 0 - 350 / 1300 rpm	350.00

**Note :** Items marked with '*' are based on **Indent Basis**.

**BOSCH**

Invented for life

Cordless 14.4 V Li-Ion

Model	Part Number	Power	Capacity	List Price (SGD)
GDR 14.4 V-LI	0 601 9A1 4L1	14.4 V / 4.0 Ah	150 Nm, 0 - 2800 rpm, 0 - 3200 bpm	870.00
GSR 14.4-2-LI	0 601 9A4 4L1	14.4 V / 2.0 Ah	0 - 400 / 1250 rpm	446.00
GSR 1440-LI	0 601 9A8 4L0	14.4 V / 1.5 Ah	0 - 420 / 1400 rpm	314.00

**Cordless 18 V Li-Ion**

GDS 18 V-LI	0 601 9A1 SL1	18 V / 2.6 Ah	170 Nm, 1/2" External square, 0 - 2800 rpm, 0 - 3200 bpm	960.00
GDS 18 V-EC	0 601 9B9 5B0	18 V / 4.0 Ah	185 Nm, 1/2" External square, 0 - 2800 rpm, 0 - 3200 bpm	960.00
GDX 18 V-EC	0 601 9B9 1L0	18 V / 4.0 Ah	185 Nm, 0 - 2800 rpm, 0 - 3200 bpm	960.00
GSR 180-LI	0 601 9F8 1L0	18 V / 1.5 Ah	34 Nm, 0 - 450 / 1700 rpm	286.00
GDR 18 V-LI*	0 601 9A1 3L0	18 V / 2.6 Ah	M6 - M14, 170 Nm, 0 - 2800 rpm, 0 - 3200 bpm	970.00
GSB 18-2-LI	0 601 9A5 3L1	18 V / 1.3 Ah	45 / 19 Nm, 0 - 500 / 1450 rpm	498.00
GBH 18 V-EC	0 611 904 0L2	18 V / 3.0 Ah	4 - 18 mm, 0 - 1000 rpm, 0 - 4400 bpm	1,160.00
GSB 180-LI	0 601 9F8 3L0	18 V / 1.5 Ah	54 / 21 Nm, 0 - 450 / 1700 rpm	310.00

**Cordless 36 V Li-Ion**

GSR 36 VE-2-LI	0 601 9C0 170	36 V / 4.0 Ah	100 Nm, 0 - 1800 rpm	1,488.00
GSA 36 V-LI	0 601 645 R72	36 V / 2.6 Ah	2400 / 3000 spm	1,400.00
GBH 36 V-LI Plus	0 611 906 0L0	36 V / 4.0 Ah	4 - 26 mm, 0 - 960 rpm, 0 - 4260 bpm	1,840.00
GBH 36 V-EC Compact	0 611 903 RL1	36 V / 2.0 Ah	4 - 18 mm, 0 - 1500 rpm, 0 - 4850 bpm	1,360.00

**Cordless Multi-Cutter**

GOP 30-28	0 601 237 0L0	300 W	8,000 - 20,000 rpm	350.00
------------------	----------------------	-------	--------------------	---------------

**Note :** Items marked with '*' are based on **Indent Basis**.

Prices are subject to change without prior notice.

**BOSCH**

Invented for life

1

SDS Plus Rotary Hammer / SDS Max Rotary Hammer / Demolition Hammer

SDS Plus Rotary Hammer

Model	Part Number	Power	Capacity		List Price (SGD)
GBH 2-20 RE	0 611 25A 3L0	600 W	2.3 kg	4 - 20 mm	296.00
GBH 2-20 DRE	0 611 25A 4L0	600 W	2.3 kg	4 - 20 mm	316.00
GBH 2-23 RE	0 611 250 4L0	650 W	2.3 kg	4 - 23 mm	348.00
GBH 2-23 RE (110V)	0 611 250 4C0	650 W	2.3 kg	4 - 23 mm	364.00
GBH 2-23 REA	0 611 250 570	710 W	3.6 kg	4 - 23 mm	596.00
GBH 2-24 RE	0 611 272 0L0	790 W	2.8 kg	4 - 24 mm	330.00
GBH 2-24 DRE	0 611 272 1L4	790 W	2.8 kg	4 - 24 mm	376.00
GBH 2-26 RE	0 611 251 706	800 W	2.7 kg	4 - 26 mm	370.00
GBH 2-26 RE (110V)	0 611 251 705	710 W	3.6 kg	4 - 23 mm	432.00
GBH 2-26 DRE	0 611 253 76C	800 W	2.7 kg	4 - 26 mm	408.00
GBH 2-26 DFR	0 611 254 76C	800 W	2.9 kg	4 - 26 mm	578.00
GBH 2-28 D	0 611 267 0L0	820 W	2.9 kg	4 - 28 mm	630.00
GBH 2-28 DFV	0 611 267 2L0	820 W	6.3 kg	4 - 28 mm	670.00
GBH 3-28 DFR	0 611 24A 0L0	800 W	3.6 kg	4 - 28 mm	770.00
GBH 4-32 DFR	0 611 332 171	900 W	4.7 kg	4 - 32 mm	1,110.00

**SDS Max Rotary Hammer**

GBH 5-40 D (110V)	0 611 269 0C0	1050 W	5.8 kg	12 - 38 mm	1,300.00
GBH 5-40 D	0 611 269 0L0	1100 W	6.8 kg	170 - 340 rpm, 1500 - 2900 bpm	1,228.00
GBH 7-46 DE* (110V)	0 611 263 705	1350 W	7.9 kg	12 - 45 mm	2,053.00
GBH 8-45 D	0 611 265 1L0	1500 W	8.2 kg	0 - 305 rpm, 1380 - 2720 bpm	1,800.00

**Demolition Hammer**

GSH 5 MAX	0 611 337 0L0	1100 W	5.6 kg	2850 bpm	740.00
GSH 5 X	0 611 338 0L0	1025 W	5.5 kg	2750 bpm	530.00
GSH 5 X (110V)	0 611 338 0C0	1025 W	5.5 kg	2750 bpm	600.00
GSH 5 X Plus	0 611 338 2L0	1025 W	5.5 kg	2750 bpm	434.00
NEW! GSH 500	0 611 338 6L0	1100 W	5.6 kg	2900 bpm	434.00
GSH 5 CE	0 611 321 0L0	1150 W	6.2 kg	1300 - 2900 bpm	1,050.00
GSH 9 VC	0 611 322 0L0	1500 W	8.5 kg	2720 bpm	1,700.00
GSH 11 E	0 611 316 706	1500 W	10.1 kg	900 - 1890 / min	1,440.00
GSH 11 VC	0 611 336 0L0	1700 W	11.4 kg	900 - 1700 bpm	2,120.00
GSH 16-30	0 611 335 1L0	1750 W	16.7 kg	45 J	2,680.00
GSH 27 VC*	0 611 30A 070	2000 W	29.5 kg	1000/min	4,200.00

**Note :** Items marked with '*' are based on **Indent Basis**.

Prices are subject to change without prior notice.

**BOSCH**

Invented for life

Straight Grinder

Model	Part Number	Power	Capacity	List Price (SGD)
GGS 3000 L	0 601 224 0J0	300 W	Collet up to 6 mm / 28000 rpm	270.00
GGS 5000	0 601 223 0L0	500 W	Collet up to 8 mm / 33000 rpm	278.00
GGS 5000 L	0 601 224 1L0	500 W	Collet up to 6 mm / 33000 rpm	326.00
GGS 28 C	0 601 220 070	650 W	Collet up to 8 mm / 28000 rpm	348.00
GGS 28 LC	0 601 221 070	650 W	Collet up to 8 mm / 28000 rpm	534.00
GGS 6 S	0 601 214 103	1200 W	Grinding abrasive 125 mm / 6800 rpm	1,076.00



Small Angle Grinder

GWS 060	0 601 375 6L0	670 W	100 mm, 11,000 rpm	92.00
GWS 6-100 (110V)	0 601 375 026	720 W	100 mm, 11,000 rpm	144.00
GWS 750	0 601 394 0L0	750 W	100 mm, 11000 rpm	140.00
GWS 9-100	0 601 396 0L0	900 W	100 mm, 10,000 rpm	166.00
GWS 9-100 S	0 601 396 1L0	900 W	100 mm, 11,000 rpm	186.00
GWS 8-100 C	0 601 377 606	850 W	1100 mm, 11,000 rpm	166.00
GWS 8-100 CE	0 601 378 644	850 W	100 mm, 2,800 - 11,000 rpm	186.00
GWS 9-100 P	0 601 396 5L0	900 W	100 mm, 11,000 rpm	186.00
GWS 9-100 P (110V)	0 601 396 5Z0	900 W	100 mm, 11,000 rpm	210.00
GWS 11-125* (110V)	0 601 792 060	1100 W	125 mm, 7,500 rpm	350.00
GWS 13-125 CI	0 601 79E 002	1300 W	125 mm, 11,500 rpm	290.00
GWS 15-125 CI	0 601 795 002	1500 W	125 mm, 11,500 rpm	350.00
GWS 17-125 CI	0 601 796 002	1700 W	125 mm, 11,500 rpm	300.00
GWS 18-125 L	0 601 7A3 0L0	1800 W	125 mm, 12,000 rpm	320.00
GWS 18-150 L	0 601 7A5 0L0	1800 W	150 mm, 10,000 rpm	360.00



Large Angle Grinder

GWS 20-180	0 601 849 106	2000 W	180 mm, 8,500 rpm	350.00
GWS 20-180 (110V)	0 601 849 105	2000 W	180 mm, 8,500 rpm	396.00
GWS 20-230	0 601 850 106	2000 W	230 mm, 6,500 rpm	464.00



Note : Item marked with “*” are based on **Indent Basis**.

**BOSCH**

Invented for life

Impact Wrench

Model	Part Number	Power	Capacity	List Price (SGD)
GDS 18 E	0 601 436 803	500 W	70 - 250 Nm, 500 - 1,300 rpm	860.00
GDS 30	0 601 435 103	920 W	500 - 1,000 Nm, 860 rpm	1,598.00

**Stirrer / Mixer Drill**

GRW 12 E	0 601 1A7 000	1200 W	12 Nm, 0 - 1,000 rpm	970.00
-----------------	----------------------	--------	----------------------	---------------

**Bench Grinder**

GBG 35-15		350 W	150 mm, 3000 rpm	264.00
GBG 60-20		600 W	200 mm, 3600 rpm	366.00

**Shear / Nibbler**

GSC 2.8*	0 601 506 103	500 W	2.8 mm, 1500 rpm	1,060.00
GNA 2.0	0 601 530 103	500 W	2.0 mm, 1500 rpm	1,050.00

**Concrete Cutter**

GDM 13-34	0 601 36A 2L0	1300 W	12,000 rpm, 2.8 kg	222.00
GDM 13-34* (110V)	0 601 36A 2C0	1300 W	12,000 rpm, 2.8 kg	256.00
GDM 121	0 601 36A 2C0	1250 W	14,500 rpm, 2.8 kg	168.00
GDC 140	0 601 3A0 0L0	1400 W	13,200 rpm, 2.9 kg	150.00

**Reciprocating Saw**

GSA 1100 E	0 601 64C 8L0	1100 W	0 - 2700 spm	370.00
GSA 1100 E* (110V)	0 601 64C 860	1100 W	0 - 2700 spm	420.00

**Note :** Item marked with '*' are based on **Indent Basis**.

**BOSCH**

Invented for life

Jigsaw

Model	Part Number	Power	Capacity	List Price (SGD)
GST 700	0 601 2A7 0L0	500 W	70 mm, 1450 - 3200 spm	168.00
GST 65* (110V)	0 601 509 1C0	400 W	65 mm, 500 - 3100 spm	190.00
GST 80 PBE	0 601 581 59F	580 W	80 mm, 550 - 3100 rpm	432.00
GST 25 M	0 601 516 0L0	670 W	80 mm, 500 - 2600 rpm	480.00



Circular Saw

GKS 600	0 601 6A9 0L0	1200 W	165 mm, 5000 rpm	220.00
GKS 190* (110V)	0 601 623 0C0	1400 W	190 mm, 5500 rpm	328.00
GKS 7000	0 601 676 0L0	1100 W	190 mm, 5200 rpm	238.00



Bench Top

GCO 2000 (110V)	0 601 B17 0C0	1800 W	3500 rpm, 17 kg	450.00
GCO 220	0 601 B37 3L0	2200 W	3800 rpm, 17 kg	310.00
GCD 12 JL	0 601 B28 000	2000 W	1500 rpm, 20 kg	1,060.00
GTS 10 J	0 601 B20 542	1800 W	254 mm, 26 kg	1,160.00
GCM 10 MX	0 601 B29 040	1700 W	4800 rpm, 255 mm, 13.5 kg	692.00
T1B*	0 601 B12 310		17 / 22 kg	340.00



Foam Rubber Cutter

GSG 300	0 601 575 103	350 W	300 mm, 3200 rpm	1,204.00
----------------	----------------------	-------	------------------	-----------------



Planer

GHO 10-82	0 601 594 006	710 W	0 - 3.0 mm	328.00
GHO 10-82* (110V)	0 601 594 005	710 W	0 - 3.0 mm	360.00
GHO 6500	0 601 596 0L0	650 W	0 - 2.6 mm	270.00



Note : Item marked with '*' are based on **Indent Basis**.

**BOSCH**

Invented for life

Orbital Sander

Model	Part Number	Power	Capacity	List Price (SGD)
GSS 230	0 601 070 0L0	180 W	93 x 230 mm, 24000 rpm	192.00
GSS 230* (110V)	0 601 070 0C0	180 W	93 x 230 mm, 24000 rpm	218.00
GSS 280 A*	0 601 293 006	330 W	114 x 226 mm, 22000 rpm	576.00
GSS 1400	0 601 2A2 0L0	180 W	24000 opm, 12000 rpm	142.00

**Belt Sander**

GBS 75 A	0 601 274 004	710 W	300 m / min	504.00
----------	---------------	-------	-------------	--------

**Multi Sander**

GEX 125-1AE	0 601 387 5L0	250 W	7500 - 12000 rpm	298.00
-------------	---------------	-------	------------------	--------

**Polisher**

GPO 12 CE	0 601 389 0J0	1250 W	750 - 3000 rpm	360.00
GPO 950	0 601 3A2 0L0	950 W	600 - 2100 rpm	270.00

**Blower**

GBL 82-270	0 601 980 4L1	820 W	4.5 m ³ / min	216.00
GBL 800 E* (110V)	0 601 980 450	800 W	4.5 m ³ / min	260.00

**Mini Router / Trimmer**

GMR 1	0 601 60A 0K0	550 W	6 mm, 33000 rpm	278.00
GKF 550	0 601 6A0 0L0	550 W	1/4", 33000 rpm	150.00

**Hot Air Gun**

GHG 18-60	0 601 2A6 1L0	1800 W	50° - 600°C, 250 / 350 / 500 l/min	155.00
GHG 20-63 kit	0 601 2A6 2L0	2000 W	50° - 630°C Variable, 150 / 300 / 500 l/min	280.00
GHG 20-63 (110V)	0 601 2A6 2C0	2000 W	50° - 630°C Variable, 150 / 300 / 500 l/min	316.00

**Note :** Items marked with '*' are based on **Indent Basis**.

**BOSCH**

Invented for life





Vacuum Cleaner

Model	Part Number	Power	Capacity	List Price (SGD)
GAS 15	0 601 9E5 0L0	1100W	15 litres	280.00
GAS 15 PS	0 601 9E5 1L0	1100W	15 litres	365.00
GAS 12-25 L	0 601 97C 0L0	1250W	25 litres	400.00



Measuring Tools



Range Finder

GLM 30	0 601 072 570		Measuring range : 0.15 - 30 meter		196.00
GLM 40	0 601 072 9K0		Measuring range : 0.15 - 40 meter		270.00
GLM 500	0 601 072 HK0		Measuring range : 0.05 - 50 meter		316.00
GLM 50 C (Bluetooth)	0 601 072 CK0		Measuring range : 0.05 - 50 meter		370.00
GLM 80	0 601 072 370		Measuring range : 0.05 - 80 meter		440.00
GLM 150 C (Bluetooth)	0 601 072 FK0		Measuring range : 0.05 - 150 meter		590.00
GLM 250 VF	0 601 072 170		Measuring range : 0.05 - 250 meter		1,020.00

Detector

D-tect 120	0 601 081 3K0		Measuring range : 120 mm		490.00
GMS 120	0 601 081 000		Measuring range : 120 mm		258.00

Leveler

GCL 2-15 G	0 601 066 J00		Working range : 15 meter		540.00
GCL 2-50 CG	0 601 066 H80		Working range : 50 meter		760.00
GLL 3-80	0 601 063 S00		Working range : 80 meter		1,480.00
GCL 25	0 601 066 B00		Working range : 10 meter		800.00
GPL 5	0 601 066 200		Working range : 30 meter		580.00
GLL 30 G	0 601 063 V80		Working range : 10 meter		265.00
GRL 300 HVG	0 601 061 600		Working range : 150 meter		2,500.00
GLL 5-40 E	0 601 063 GB0		Working range : 40 meter		1,130.00
GLL 8-40 E	0 601 063 HB0		Working range : 40 meter		1,560.00
GLL 3-15 X	0 601 063 M80		Working range : 15 meter		290.00
GLL 5-50 X	0 601 063 N80		Working range : 50 meter		380.00
GLL 3-80 CG	0 601 063 U80		Working range : 80 meter		1,800.00

Cordless Inspection Camera

GIC 120	0 601 241 100		Display size : 2.7"		900.00
GIC 120 C	0 601 241 2K0		Display size : 3.5"		1,400.00

Cordless Thermo Detector

GIS 1000 C	0 601 083 340		Temperature range: -40 ~ + 1000°C		960.00
GTC 400 C	0 601 083 150		Temperature range: -10 ~ to 400°C		2,500.00

Note : Items marked with '**' are based on **Indent Basis**.

**BOSCH**

Invented for life

H

Measuring Tools

Measuring Tools

Model	Part Number	Capacity	List Price (SGD)
Angle Measurer			
DWM 40 L*	0 601 096 663	Measuring range : 0° - 220°	464.00
Digital Inclinometer			
GIM 60 L	0 601 076 300	Measuring range : 0° - 360° (4x90°), Length : 60cm	530.00
DNM 60 L*	0 601 014 000	Measuring range : 0° - 360° (4x90°), Length : 60cm	464.00
DNM 120 L*	0 601 014 100	Measuring range : 0° - 360° (4x90°), Length : 120cm	550.00
Receiver			
LR1	0 601 015 400	Rotation Laser Light Receiver for GRL 150HV	264.00
LR2	0 601 069 100	Line Laser Light Receiver for GLL category	192.00
Stand			
BT 150	0 601 096 B00	Professional Building Tri-pod : 1/4" Tri-pod Thread 150 cm for all DLE, GLM, GLL & GPL Category	54.00
BT 160	0 601 091 200	Professional Building Tri-pod : 5/8" Tri-pod Thread 160 cm for all GRL 150 VH, GLL 2-80 & GOL 26D	140.00
BT 170 HD	0 601 091 300	Professional Building Tri-pod : 5/8" Tri-pod Thread 170 cm for all GRL 150 VH, GLL 2-80 & GOL 26D	190.00
BM 1	0 601 015 A01	Mounting Tools for GLL & GPL Category	91.00
Measuring Rail			
R60	0 601 079 000	For GLM 80	90.00
Rod			
GR 240	0 601 094 100	Professional Leveling Rod : 2 m	140.00
GR 500	0 601 094 300	Professional Leveling Rod : 500 cm for GOL 26D	110.00
Telescopic Pole			
BT 350	0 601 015 B00	Professional Telescopic Pole : 350 cm for GLL & GPL Category	240.00

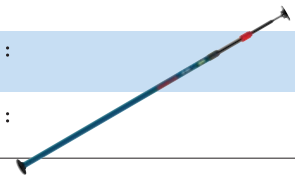
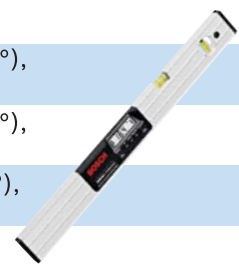
**Note :** Items marked with '*' are based on **Indent Basis**.

EasyAquatak 110

EasyAquatak 120

UniversalAquatak 130

AdvancedAquatak 150

High Pressure Cleaner (Suitable for Home Use)

Model	Part Number	Power	Capacity	List Price (SGD)
Easy Aquatak 100	0 600 8A7 ELO	1,200 W	100 bar	245.00
Easy Aquatak 110	0 600 8A7 FLO	1,300 W	110 bar	265.00
Easy Aquatak 120	0 600 8A7 9LO	1,500 W	120 bar	320.00
Universal Aquatak 130	0 600 8A7 BLO	1,700 W	130 bar	520.00
Advance Aquatak 140	0 600 8A7 DLO	2,100 W	140 bar	950.00
Advance Aquatak 150	0 600 8A7 7LO	2,200 W	150 bar	1,060.00

High Pressure Cleaner (Suitable for Industrial Use)

Model	Part Number	Power	Pressure	Flow Rate	List Price (SGD)
GHP 5-13 C	0 600 910 0K0	2,300 W	140 bar	520 L/H	1,330.00
GHP 6-14	0 600 910 2K0	2,600 W	150 bar	650 L/H	1,840.00



Rotary Nozzle

90° Nozzle

Extension Hose 6m

Drain Cleaner 10m

Water Filter

Self-priming kit

Vario Fan Jet Nozzle

Trio Nozzle

Bosch 360° Gun

High Pressure Cleaner Accessories

Part Number	Description	List Price (SGD)
For Models Aquatak 33-10, Aquatak 33-11, Aquatak 35-12 Plus & Aquatak 37-13 Plus		
F 016 800 580	Rotary Nozzle	24.50
F 016 800 581	90° Nozzle	20.40
F 016 800 360	High Pressure Hose 6m	27.20
F 016 800 361	Extension Hose 6m	24.50
F 016 800 362	Drain Cleaner 10m	40.80
F 016 800 577	Water Filter	8.20
F 016 800 421	Self-priming kit	35.00
F 016 800 422	HPW DIY Emergency Accessory Kit	92.00
F 016 800 582	Vario Fan Jet Nozzle	17.00
F 016 800 583	Trio Nozzle	25.00
F 016 800 536	Bosch 360° Gun	42.00
F 016 800 509	450° Detergent Nozzle	25.00

Accessory Range



Miscellaneous

Part Number	Description	List Price (SGD)
1 2 607 990 050	S 41 - Drill Bit Sharpener (2.5mm to 10mm)	80.40
2 608 600 029	S 41 - Grinding Stone	27.40
2 607 001 356	Universal Spray (250ml)	15.40
2 608 570 047	Collet 6.0 mm	(For Model POF 500, POF 400, GGS 5000 & GGS 5000 L) 11.80
2 608 570 084	Collet 6.0 mm with Sleeve Nut	(For Model 1205, 1211 & GGS 27 L) 41.20
1 602 025 024	Handle (M 10)	(For Model GWS 6-100, GWS 8-100 C & GWS 8-100 CE) 2.50
2 607 010 025	Upper and Lower Blade Set	(For Model 1506 & GSC 2.8) 46.90
2 608 838 999	Straight, TC Blade - Reversible (x2)	(For Model GHO 10-82 & GHO 6500) 18.50
3 609 201 038	Stirrer Basket	(For Model GRW 11E) 86.00
NEW! Bosch Diamond Drill Bit		
2 2 607 011 626	Diamond Drill Bit 3 pcs Set (6 / 6 / 8 mm)	43.50
2 608 599 049	6 mm Diamond Drill Bit	13.90
2 608 599 050	8 mm Diamond Drill Bit	15.00
2 608 599 051	10 mm Diamond Drill Bit	16.90
2 608 599 052	12 mm Diamond Drill Bit	19.90

Straight Shank Drill Bit

Ceramic Expert Drill Bit		
2 608 587 157	3 x 70 mm	5.60
158	4 x 70 mm	5.60
159	5 x 70 mm	6.20
160	5.5 x 70 mm	6.20
161	6 x 80 mm	6.20
162	6.5 x 80 mm	6.20
163	7 x 80 mm	8.10
164	8 x 80 mm	8.10
165	10 x 90 mm	9.40
166	12 x 90 mm	10.70
167	14 x 90 mm	11.30
168	16 x 90 mm	11.90
NEW! Bosch Hex-9 Hard Ceramic Drill Bit		
3 2 608 579 503	Hex-9 Hard Ceramic Bit (3 x 70 mm)	6.80
504	Hex-9 Hard Ceramic Bit (4 x 70 mm)	6.80
505	Hex-9 Hard Ceramic Bit (5 x 70 mm)	7.00
506	Hex-9 Hard Ceramic Bit (6 x 70 mm)	7.00
507	Hex-9 Hard Ceramic Bit (7 x 80 mm)	9.80
508	Hex-9 Hard Ceramic Bit (8 x 80 mm)	9.80
509	Hex-9 Hard Ceramic Bit (10 x 90 mm)	11.20
510	Hex-9 Hard Ceramic Bit (12 x 90 mm)	12.80
511	Hex-9 Hard Ceramic Bit 3 pcs Set (5 / 6 / 8 mm)	22.20
Flat Wood Bit		
2 608 595 484	Spade Bits Self Cut (12 x 152 mm)	7.70
486	Spade Bits Self Cut (14 x 152 mm)	7.70
487	Spade Bits Self Cut (16 x 152 mm)	7.80
488	Spade Bits Self Cut (18 x 152 mm)	8.00
489	Spade Bits Self Cut (20 x 152 mm)	8.10
491	Spade Bits Self Cut (22 x 152 mm)	8.10
492	Spade Bits Self Cut (24 x 152 mm)	8.60
494	Spade Bits Self Cut (25 x 152 mm)	9.00
Cobalt Drill Bit		
2 608 585 842	3.0 mm	4.20
843	3.2 mm	4.40
845	3.5 mm	4.60
846	4.0 mm	5.20
849	4.5 mm	5.60
851	5.0 mm	6.10
854	5.5 mm	7.00
855	6.0 mm	7.70
856	6.5 mm	9.20
860	8.0 mm	11.00
864	10.0 mm	19.70

**BOSCH**

Invented for life



1



3



5



2



4



6



7



8

Straight Shank Drill Bit

Part Number	Description	List Price (SGD)
Cylindrical Shank Drill Bit CYL-5 (New Blue Granite Bit)		
2 608 588 136	CYL-5 3 x 50 x 90 mm	6.00
137	CYL-5 3.5 x 50 x 90 mm	5.70
138	CYL-5 4 x 50 x 90 mm	5.30
139	CYL-5 4 x 100 x 140 mm	4.30
140	CYL-5 5 x 50 x 100 mm	5.30
141	CYL-5 5 x 100 x 150 mm	4.70
142	CYL-5 5.5 x 50 x 100 mm	4.60
143	CYL-5 5.5 x 100 x 150 mm	4.70
144	CYL-5 6 x 50 x 100 mm	5.00
145	CYL-5 6 x 100 x 150 mm	4.90
146	CYL-5 6 x 200 x 250 mm	7.30
147	CYL-5 6.5 x 50 x 100 mm	4.90
148	CYL-5 6.5 x 100 x 150 mm	5.10
149	CYL-5 7 x 50 x 100 mm	4.90
150	CYL-5 7 x 100 x 150 mm	5.30
151	CYL-5 8 x 50 x 100 mm	5.50
152	CYL-5 8 x 100 x 150 mm	5.40
153	CYL-5 8 x 200 x 250 mm	7.80
154	CYL-5 9 x 50 x 100 mm	5.50
155	CYL-5 10 x 100 x 150 mm	6.70
156	CYL-5 10 x 200 x 250 mm	8.90
157	CYL-5 12 x 90 x 150 mm	7.80
158	CYL-5 12 x 190 x 250 mm	9.40
159	CYL-5 14 x 190 x 150 mm	11.40
160	CYL-5 14 x 190 x 250 mm	10.80
161	CYL-5 16 x 140 x 200 mm	13.60
162	CYL-5 18 x 140 x 200 mm	15.90
163	CYL-5 20 x 140 x 200 mm	21.00
CYL-2 Concrete Drill Bit		
2 608 578 114	CYL-2 Concrete Drill bit 3 x 30 x 60	0.75
115	CYL-2 Concrete Drill bit 4 x 40 x 75	0.80
116	CYL-2 Concrete Drill bit 5 x 50 x 85	0.90
117	CYL-2 Concrete Drill bit 5.5 x 50 x 85	1.00
118	CYL-2 Concrete Drill bit 6 x 60 x 100	1.00
119	CYL-2 Concrete Drill bit 6.5 x 60 x 100	1.10
120	CYL-2 Concrete Drill bit 8 x 80 x 120	1.40
159	CYL-2 Concrete Drill bit 9 x 80 x 120	1.65
121	CYL-2 Concrete Drill bit 10 x 80 x 120	2.00
122	CYL-2 Concrete Drill bit 12 x 90 x 150	3.00
123	CYL-2 Concrete Drill bit 14 x 90 x 150	4.00
160	CYL-2 Concrete Drill bit 16.0 x 90 x 150	4.60
124	CYL-2 Concrete Drill bit (6 / 8 / 10)	4.60
155	CYL-2 Concrete Drill bit (4 / 5 / 6 / 8 / 10)	6.30
156	CYL-2 Concrete Drill bit (3 / 4 / 5 / 6 / 7 / 8 / 9 / 10)	7.00
1	2 608 680 696 Multi Purpose Drill Bit 3 x 40 x 70 mm (CYL-4)	2.20
697	Multi Purpose Drill Bit 4 x 40 x 75 mm (CYL-4)	2.70
698	Multi Purpose Drill Bit 5 x 50 x 85 mm (CYL-4)	3.00
699	Multi Purpose Drill Bit 5.5 x 50 x 85 mm (CYL-4)	3.10
792	Multi Purpose Drill Bit 6 x 60 x 100 mm (CYL-4)	3.60
793	Multi Purpose Drill Bit 6.5 x 60 x 100mm (CYL-4)	3.80
794	Multi Purpose Drill Bit 7 x 60 x 100 mm (CYL-4)	3.90
795	Multi Purpose Drill Bit 8 x 80 x 120 mm (CYL-4)	4.80
796	Multi Purpose Drill Bit 10 x 80 x 120 mm (CYL-4)	7.50
797	Multi Purpose Drill Bit 12 x 90 x 150 mm (CYL-4)	8.80
2	798 Multi Purpose Drill Bit 5 piece Set (4, 5, 6, 8 & 10 mm) (CYL-4)	21.30
3	1 609 200 226 Wood Bit Set (3 - 10 mm)	18.00
4	203 HSS Bit Set (2, 3, 4, 5, 6, 7, 8, 9 & 10 mm)	19.00
	201 HSS Drill Bit (1.5 - 6.5 mm / 13 pieces) - Refer 2 607 018 360	14.00
	227 Mixed Set - 4 Twist Drill Bits / 5 Masonry Bits	19.60
5	1 607 950 028 Key (4 mm) For GBM 350 / GBM 350 RE	5.00
	045 Key (6 mm) For GSB 13 RE / GSB 16 RE	6.60
	042 Key (For Battery Drill)	5.30
	041 Key (5/8") For GSB 10 RE	10.00
	053 Key (For Battery Drill)	5.60
	1 612 025 020 Auxiliary Handle (GBM 13 HRE)	11.60
	2 607 990 031 Laser Goggle	15.30
6	041 Goggle - Replacing 1 607 990 000	6.90
7	038 Welding Goggle	27.00
8	1 609 200 291 Paint Stirrer	5.70
	2 607 019 325 33pcs Promoline	24.70
	115 10's HSS-G	32.50

Prices are subject to change without prior notice.

1

2

3

D-point

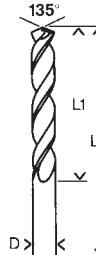

DIN 338, cobalt content 5%.
 Right-hand cutting Type N,
 drill bit tip 135°, split point
 manufactured to DIN 1412 C,
 diameter tolerance h 8.
 Suitable for drilling - only with
 cooling - in alloyed and unalloyed
 steel up to a tensile strength of
 1000 N/mm², stainless steel V2A/V4A,
 cast iron.

HSS-G Set

Part Number	Diameter (mm)	Packing (piece)	Working length L1 (mm)	Total length L2 (mm)	List Price (SGD)
HSS-G Set					
1 2 607 019 114	2,3,4,5 & 6	Tube x 5			7.10
115	1 to 10 (by 1.0 mm)	Cassette x 10			29.60
116	1 to 10 (by 0.5 mm)	Metal Box x 19			58.20

1/4" Hex Shank HSS G Metal Drill Bit

2 2 608 577 045	2	1	24	62	2.30
048	3	1	33	74	3.40
052	4	1	43	88	4.10
056	5	1	52	99	4.10
058	6	1	63	106	4.60
061	8	1	75	117	7.50

HSS G Cobalt 135° Metal Drill Bit Suitable for V2A & V4A (INOX) Stainless Steel or Pipe

3 2 608 585 872	1	10	12	34	13.70
873	1.5	10	18	40	13.70
874	2	10	24	49	13.70
875	2.5	10	30	57	14.00
876	3	10	33	61	14.90
877	3.2	10	36	65	15.60
878	3.3	10	36	65	15.60
879	3.5	10	39	70	18.40
880	4	10	43	75	20.60
881	4.1	10	43	75	20.60
882	4.2	10	43	75	20.60
883	4.5	10	47	80	23.40
884	4.8	10	52	86	29.20
885	5	10	52	86	29.20
886	5.1	10	52	86	32.90
887	5.2	10	52	86	32.90
888	5.5	10	57	93	37.20
889	6	10	57	93	38.60
890	6.5	10	63	101	47.10
891	6.8	10	69	109	52.30
892	7	10	69	109	52.30
893	7.5	10	69	109	52.30
894	8	5	75	117	32.90
895	8.5	5	75	117	36.50
896	9	5	81	125	43.20
897	9.5	5	81	125	47.70
898	10	5	87	133	55.50
899	10.2	5	87	133	56.50
900	10.5	5	87	133	56.50
901	11	5	94	142	70.50
902	11.5	5	94	142	79.70
903	12	5	101	151	79.70
904	12.5	5	101	151	90.80
905	13	5	101	151	101.80

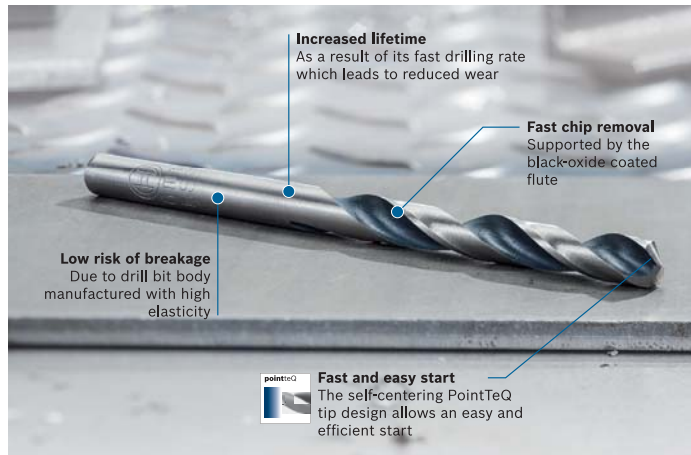

HSS-PointTeQ Metal Drill Bit

Part Number	Description	List Price (SGD)
NEW! HSS-PointTeQ Metal Drill Bit		
2 608 577 178	HSS-PointTeQ 1.0 mm (10 pcs pack)	4.00
2 608 577 179	HSS-PointTeQ 1.1 mm (10 pcs pack)	4.00
2 608 577 180	HSS-PointTeQ 1.2 mm (10 pcs pack)	4.00
2 608 577 181	HSS-PointTeQ 1.3 mm (10 pcs pack)	4.00
2 608 577 182	HSS-PointTeQ 1.4 mm (10 pcs pack)	4.00
2 608 577 183	HSS-PointTeQ 1.5 mm (10 pcs pack)	4.00
2 608 577 184	HSS-PointTeQ 1.6 mm (10 pcs pack)	4.50
2 608 577 185	HSS-PointTeQ 1.7 mm (10 pcs pack)	4.50
2 608 577 186	HSS-PointTeQ 1.8 mm (10 pcs pack)	4.50
2 608 577 187	HSS-PointTeQ 1.9 mm (10 pcs pack)	4.50
2 608 577 188	HSS-PointTeQ 2.0 mm (10 pcs pack)	4.50
2 608 577 189	HSS-PointTeQ 2.1 mm (10 pcs pack)	4.50
2 608 577 190	HSS-PointTeQ 2.2 mm (10 pcs pack)	4.50
2 608 577 191	HSS-PointTeQ 2.3 mm (10 pcs pack)	4.50
2 608 577 192	HSS-PointTeQ 2.4 mm (10 pcs pack)	4.50
2 608 577 193	HSS-PointTeQ 2.5 mm (10 pcs pack)	4.50
2 608 577 194	HSS-PointTeQ 2.6 mm (10 pcs pack)	5.00
2 608 577 195	HSS-PointTeQ 2.7 mm (10 pcs pack)	5.00
2 608 577 196	HSS-PointTeQ 2.8 mm (10 pcs pack)	5.00
2 608 577 197	HSS-PointTeQ 2.9 mm (10 pcs pack)	5.00
2 608 577 198	HSS-PointTeQ 3.0 mm (10 pcs pack)	5.00
2 608 577 199	HSS-PointTeQ 3.1 mm (10 pcs pack)	5.60
2 608 577 200	HSS-PointTeQ 3.2 mm (10 pcs pack)	5.60
2 608 577 201	HSS-PointTeQ 3.3 mm (10 pcs pack)	5.60
2 608 577 202	HSS-PointTeQ 3.4 mm (10 pcs pack)	5.60
2 608 577 203	HSS-PointTeQ 3.5 mm (10 pcs pack)	5.60
2 608 577 204	HSS-PointTeQ 3.6 mm (10 pcs pack)	6.80
2 608 577 205	HSS-PointTeQ 3.7 mm (10 pcs pack)	6.80
2 608 577 206	HSS-PointTeQ 3.8 mm (10 pcs pack)	6.80
2 608 577 207	HSS-PointTeQ 3.9 mm (10 pcs pack)	6.80
2 608 577 208	HSS-PointTeQ 4.0 mm (10 pcs pack)	8.50
2 608 577 209	HSS-PointTeQ 4.1 mm (10 pcs pack)	9.00
2 608 577 210	HSS-PointTeQ 4.2 mm (10 pcs pack)	9.00

**BOSCH**

Invented for life

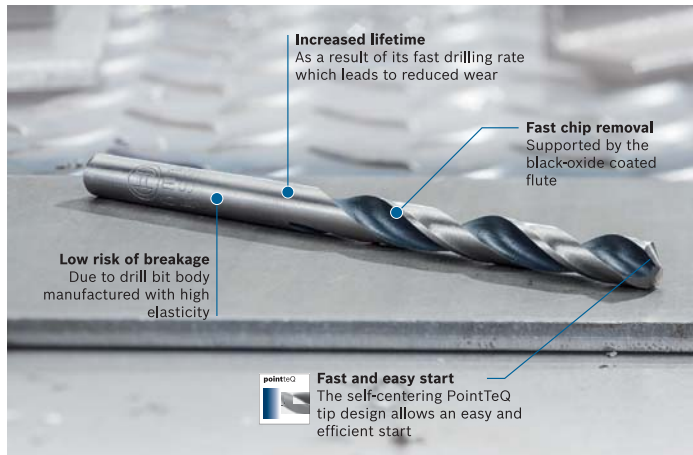

HSS-PointTeQ Metal Drill Bit

Part Number	Description	List Price (SGD)
NEW! HSS PointTeq Metal Drill Bit		
2 608 577 211	HSS-PointTeQ 4.3 mm (10 pcs pack)	9.00
2 608 577 212	HSS-PointTeQ 4.4 mm (10 pcs pack)	9.00
2 608 577 213	HSS-PointTeQ 4.5 mm (10 pcs pack)	9.00
2 608 577 214	HSS-PointTeQ 4.6 mm (10 pcs pack)	10.80
2 608 577 215	HSS-PointTeQ 4.7 mm (10 pcs pack)	10.80
2 608 577 216	HSS-PointTeQ 4.8 mm (10 pcs pack)	10.80
2 608 577 217	HSS-PointTeQ 4.9 mm (10 pcs pack)	10.80
2 608 577 218	HSS-PointTeQ 5.0 mm (10 pcs pack)	10.80
2 608 577 219	HSS-PointTeQ 5.1 mm (10 pcs pack)	13.80
2 608 577 220	HSS-PointTeQ 5.2 mm (10 pcs pack)	13.80
2 608 577 221	HSS-PointTeQ 5.3 mm (10 pcs pack)	13.80
2 608 577 222	HSS-PointTeQ 5.4 mm (10 pcs pack)	13.80
2 608 577 223	HSS-PointTeQ 5.5 mm (10 pcs pack)	13.80
2 608 577 224	HSS-PointTeQ 5.6 mm (10 pcs pack)	15.60
2 608 577 225	HSS-PointTeQ 5.7 mm (10 pcs pack)	15.60
2 608 577 226	HSS-PointTeQ 5.8 mm (10 pcs pack)	15.60
2 608 577 227	HSS-PointTeQ 5.9 mm (10 pcs pack)	15.60
2 608 577 228	HSS-PointTeQ 6.0 mm (10 pcs pack)	15.60
2 608 577 233	HSS-PointTeQ 6.5 mm (10 pcs pack)	16.80
2 608 577 238	HSS-PointTeQ 7.0 mm (10 pcs pack)	20.00
2 608 577 243	HSS-PointTeQ 7.5 mm (10 pcs pack)	22.50
2 608 577 248	HSS-PointTeQ 8.0 mm (10 pcs pack)	32.00
2 608 577 253	HSS-PointTeQ 8.5 mm (10 pcs pack)	32.00
2 608 577 258	HSS-PointTeQ 9.0 mm (10 pcs pack)	40.00
2 608 577 263	HSS-PointTeQ 9.5 mm (10 pcs pack)	40.00
2 608 577 268	HSS-PointTeQ 10.0 mm (10 pcs pack)	40.00
2 608 577 273	HSS-PointTeQ 10.5 mm (5 pcs pack)	24.50
2 608 577 278	HSS-PointTeQ 11.0 mm (5 pcs pack)	27.00
2 608 577 283	HSS-PointTeQ 11.5 mm (5 pcs pack)	29.00
2 608 577 288	HSS-PointTeQ 12.0 mm (5 pcs pack)	32.00
2 608 577 293	HSS-PointTeQ 12.5 mm (5 pcs pack)	33.50
2 608 577 298	HSS-PointTeQ 13.0 mm (5 pcs pack)	36.00

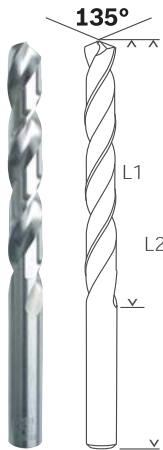
135° split point

Precise drilling

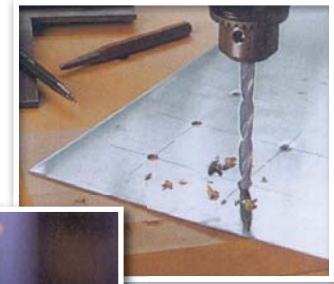
German industrial norm DIN 338

HSS-G Metal Drill Bit

Part Number	Diameter (mm)	Packing (piece)	Working length L1 (mm)	Total length L2 (mm)	List Price (SGD)
HSS-G Metal Drill Bit					
2 608 595 049	1.0	10	12	34	11.40
050	1.5	10	18	40	9.20
051	2.0	10	24	49	9.20
052	2.2	10	27	53	9.20
053	2.5	10	30	57	9.40
054	2.8	10	33	61	9.80
055	3.0	10	33	61	10.20
056	3.2	10	36	65	10.60
057	3.3	10	36	65	10.60
058	3.5	10	39	70	12.40
332	3.6	10	39	70	12.40
059	4.0	10	43	75	13.80
060	4.2	10	43	75	13.80
333	4.4	10	47	80	15.80
061	4.5	10	47	80	15.80
334	4.8	10	52	86	17.40
062	5.0	10	52	86	17.40
063	5.2	10	52	86	19.80
064	5.5	10	57	93	22.40
065	5.8	10	57	93	23.20
066	6.0	10	57	93	23.20
067	6.2	10	63	101	26.80
335	6.4	10	63	101	28.20
068	6.5	10	63	101	28.20
336	6.7	10	63	101	28.20
069	6.8	10	69	109	31.40
070	7.0	10	69	109	31.40
337	7.2	10	69	109	31.40
071	7.5	10	69	109	31.40
072	8.0	5	75	117	19.80
073	8.5	5	75	117	21.80
074	8.8	5	81	125	25.80
075	9.0	5	81	125	25.80
076	9.5	5	81	125	28.60
338	9.8	5	87	133	33.20
077	10.0	5	87	133	33.20
078	10.5	5	87	133	33.80
079	11.0	5	94	142	42.40
080	11.5	5	94	142	38.80
081	12.0	5	101	151	47.80
082	12.5	5	101	151	54.60
083	13.0	5	101	151	61.00

**BOSCH**

Invented for life



Sanding & Polishing for Drill

Part Number	Description	List Price (SGD)
1 1 609 200 154	5" Rubber Backing pad (Velcro)	17.50
240	5" Rubber Backing Pad	5.70
2 245	5" Lambswool Bonnet	8.10
3 250	5" Polishing Sponge (With rubber backing pad)	13.50
4 160	5" Sanding Paper - Coarse / Grit 40 (5 piece pack)	3.60
161	5" Sanding Paper - Coarse / Grit 60 (5 piece pack)	3.60
162	5" Sanding Paper - Medium / Grit 80 (5 piece pack)	3.60
163	5" Sanding Paper - Fine / Grit 120 (5 piece pack)	3.60
164	5" Sanding Paper - Very Fine / Grit 180 (5 piece pack)	3.60
165	5" Sanding Paper - Grit 40, 60, 80, 120 & 180 (2 piece each)	6.40
5 287	Flap Wheel 50 x 20 mm (Grit 60)	12.10
288	Flap Wheel 50 x 20 mm (Grit 120)	12.80
2 608 622 052	Nylon Wire Cup Brushes, Ao Coated K80, 6 x 50 mm	16.90
056	Nylon Wire Wheel, Ao Coated K80, 6 x 75 mm	16.90

De-rusting Accessories for Drill

6 1 609 200 269	Pencil Wire Brush - Crimped 0.3 x 25 mm	10.00
7 270	Wire Brush - Crimped 0.3 x 70 mm	7.10
271	Wire Brush - Crimped 0.2 x 70 mm	9.40
2 608 622 022	Wire Brush - Crimped 0.2 x 50 mm	6.60
008	Wire Brush - Crimped, brass coated 0.2 x 50 mm	9.20
8 1 609 200 273	Wire Wheel - Crimped 0.3 x 100 mm	9.60
274	Wire Wheel - Crimped 0.2 x 100 mm	6.60
2 608 622 007	Wire Wheel - Crimped 0.3 x 75 mm	7.00
009	Wire Wheel - Crimped, brass coated 0.2 x 75 mm	7.70

Shaping Accessories for Drill

9 1 609 200 307	Set (3 pieces) of Wood Rasp	59.80
10 314	Set (4 pieces) of Rasp Files - iron, non-ferrous metal	36.70
11 286	Set (5 pieces) of Mounted Grinding Stone	15.70
12 243	Hole Saw (8 piece Set) - 25 mm to 68 mm	19.30
244	Hole Saw 80 mm	20.20

Screwdriver Bit

13 2 608 521 042	Screw Bit (PH2-65) (10pcs) Gold	13.70
043	Screw Bit (PH2-110) (10pcs) Gold	19.70
2 608 522 255	Screw Bit (PH2-150) (5pcs) Gold	21.50
2 608 522 257	Screw Bit (PH2-200) (5pcs) Gold	26.40
2 608 522 259	Screw Bit (PH2-300) (5pcs) Gold	37.10
2 608 522 405	Impact Screwdriver Bit (PH2-65) (10pcs) Black	25.40
2 608 522 406	Impact Screwdriver Bit (PH2-110) (10pcs) Black	35.10
2 608 522 407	Impact Screwdriver Bit (PH2-150) (5pcs) Black	27.30
2 608 522 408	Impact Screwdriver Bit (PH2-65) (2pcs)	5.60
2 608 522 409	Impact Screwdriver Bit (PH2-110) (2pcs)	7.80
2 608 522 410	Impact Screwdriver Bit (PH2-150) (2pcs)	12.00
14 2 607 018 387	Screwdriver Bit Set (16 pieces) Iso-Temp	25.90
15 2 607 000 333	Screwdriver Bit Set (20 pieces) Iso-Temp	65.50
2 607 019 453	16's Mix Screwdriver Bit Set	15.50
2 607 002 556	8's Ph 1, Ph 2, Ph 3 (49 mm)	16.80
2 607 002 559	8's T8, to T40 (49 mm)	17.50
2 607 001 658	T30 X 89 mm Torque Bit	5.70
2 607 017 063	32's Screw Bit Set	25.00

Prices are subject to change without prior notice.

27

3

Others

**BOSCH**

Invented for life



1



3



5



2



4



6



7

Battery Tool Accessories

	Part Number	Description	List Price (SGD)
Batteries			
	2 607 335 708	Batt 'O' Pack 9.6 V (1.5 Ah) (GSR 9.6-2)	78.00
	2 607 335 710	Batt 'O' Pack 12 V (1.5 Ah) (GSR 12-2)	96.00
	2 607 335 712	Batt 'O' Pack 14.4 V (1.5 Ah) (GSR 14.4-2)	111.00
1	2 607 335 260	9.6 V / 2.0 Ah For GDR 9.6 V	112.00
	2 607 335 262	12 V / 2.0 Ah For GDR 12 V	146.00
	2 607 335 676	12 V / 2.4 Ah Heavy Duty, Nicd	185.00
	2 607 335 684	12 V / 2.6 Ah Nimh For GDS 12 V	198.00
	2 607 335 678	14.4 V / 2.4 Ah Heavy Duty, Nicd	161.00
	2 607 335 686	14.4 V / 2.6 Ah Nimh	190.00
2	2 607 335 082	24 V / 1.7 Ah With Charge Level Indicator For GBH 24 VRE	341.00
	2 607 335 448	24 V / 2.4 Ah For GBH 24 V (2005 Version)	352.00
	2 607 336 242	Li-Ion 3.6 V / 1.3 Ah (GSR Pro-Drive 3.6 V)	46.00
3	2 607 336 014	Li-Ion Battery 10.8 V / 1.3 Ah (GSR 10.8-2-LI, GDR 10.8 LI)	106.00
	2 607 336 002	Li-Ion Battery Pack (36 V / 1.3 Ah)	347.00
4	2 607 336 108	Li-Ion Battery 36 V / 2.6 Ah	558.00
Charger			
5	2 607 224 391	AL 60 DV (1411) - (7.2 - 14.4 V)	71.50
	2 607 225 030	AL 2450 DV (7.2 V - 24 V) Quick Charger	105.00
6	2 607 225 514	AL 1115 CV (GSR Pro-Drive 3.6 V)	89.00
7	2 607 225 902	AL 3680 (GBH 36 V)	218.00

**BOSCH**

Invented for life

**1****2****3****3****Grinding & Cutting (Metal)**

125 mm X-LOCK Accessories

Part Number	Description	List Price (SGD)
NEW! 125 mm X-LOCK Accessories		
2 608 624 136	SCM Disc extra coarse 125 mm (1 pc)	5.60
2 608 624 137	SCM Disc coarse 125 mm (1 pc)	5.60
2 608 624 138	SCM Disc medium 125 mm (1 pc)	5.60
2 608 624 139	SCM Disc very fine 125 mm (1 pc)	5.00
2 608 601 724	X-LOCK SCM Baking Pad 125 mm (1 pc)	49.00
2 608 619 201	X-LOCK Metal Flap disc Ø125 mm, G 40 (1 pc)	6.80
2 608 619 202	X-LOCK Metal Flap disc Ø125 mm, G 60 (1 pc)	6.80
2 608 619 203	X-LOCK Metal Flap disc Ø125 mm, G 80 (1 pc)	6.80
2 608 619 204	X-LOCK Metal Flap disc Ø125 mm, G 120 (1 pc)	6.00
1 2 608 619 259	X-LOCK Metal Grinding Disc 125 x 6 x 22.23 mm (1 pc)	2.30
2 608 619 262	X-LOCK Inox Cutting Disc 125 x 1 x 22.23 mm (1 pc)	1.00
2 608 619 284	X-LOCK Carbide Multi Wheel 125 mm (1 pc)	7.00
2 2 608 620 727	X-LOCK Cup Brush Knotted (75 mm x 0.5 mm) (1 pc)	9.50
2 608 615 138	X-LOCK DCD for Ceramic 125 x 22.23 x 1.6 x 7 mm (1 pc)	12.00
3 2 608 615 166	X-LOCK DCD for Universal 125 x 22.23 x 2.0 x 10 mm (1 pc)	12.00

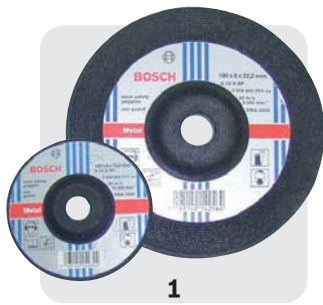

1



2



Angle Grinder & Cut Off Machine Accessories

	Part Number	Description	List Price (SGD)
Bonded Abrasive for Angle Grinder & Cut Off Machine Grinding Disc			
1	2 608 600 017	Grinding Disc (4") (101.6 mm x 6.0 mm x 16.0 mm)	0.95
	2 608 600 263	Grinding Disc (5") (127 mm x 6.0 mm x 22.2 mm)	2.05
	2 608 600 389	Grinding Disc (6") (152.4 mm x 6.0 mm x 22.2 mm)	4.30
	2 608 600 264	Grinding Disc (7") (177.8 mm x 6.0 mm x 22.2 mm)	2.75
	2 608 600 265	Grinding Disc (9") (228.6 mm x 6.0 mm x 22.2 mm)	4.45
	2 608 620 690	Inox Flexible Grinding Disc (4") (100 mm x 2mm x 16 mm)	1.65
Cutting Disc			
2	2 608 901 468	Cutting Disc - Stainless Steel (105 mm x 1.0 mm x 16 mm)	1.20
	2 608 619 343	Cutting Disc Metal (105 mm x 1.2 mm x 16 mm)	0.50
NEW!	2 608 900 531	105 mm Diamond Metal Wheel	25.00
	2 608 600 267	Cutting Disc (4") (100 mm x 2.0 mm x 16 mm)	0.95
	2 608 600 270	Cutting Disc (5") (127 mm x 3.0 mm x 22.2 mm)	1.45
	2 608 600 382	Cutting Disc (6") (152.4 mm x 2.5 mm x 22.2 mm)	2.20
	2 608 600 272	Cutting Disc (7") (177.8 mm x 3.0 mm x 22.2 mm)	2.05
	2 608 600 274	Cutting Disc (9") (228.6 mm x 3.0 mm x 22.2 mm)	3.25
	2 608 600 276	Cutting Disc (12") (304.8 mm x 3.0 mm x 25.4 mm)	5.50
	2 608 600 277	Cutting Disc (14") (355.6 mm x 3.0 mm x 25.4 mm)	7.20
	2 608 619 276	Cutting Disc - Heavy Metal (14") (355.6 mm x 3.0 mm x 25.4 mm)	6.65
NEW!	2 608 619 378	14" Standard Metal Cutting Disc	3.70
	2 608 600 428	Cutting Disc (16") (406.4 mm x 3.6 mm x 25.4 mm)	15.60
Accessories for GWS 12-76 V-EC			
	2 608 601 520	Inox / Metal Cutting Disc (76 x 10 mm) 5pcs pack	9.50
	2 608 615 020	Diamond Disc (76 x 10 mm)	11.50
	2 608 623 011	Carbide Multi Wheel (76 x 10 mm)	23.50
Rubber Pad			
	2 608 601 209	Rubber Pad (180 mm / M 14)	24.80
	1 608 601 033	Rubber Pad (125 mm / M 14)	14.20
	2 608 601 046	Rubber Pad (100 mm / M 10)	12.90

1

3

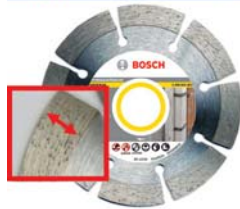
2
NEW! 12mm Segment Height

4

Diamond Cutting Disc

Part Number	Description	List Price (SGD)
Diamond Blade for Grinder & Concrete Cutter		
1 2 608 603 729	Continuous disc 105 x 16/20 mm for Tiles (Replacement of 2 608 602 180)	5.00
2 2 608 603 728	Segmented disc 105 x 16/20 mm for Marble and Granite (Replacement of 2 608 602 179)	5.80
3 2 608 603 309	Segmented disc 105 x 16/20 mm for Universal (12mm Segment)	9.00
2 608 676 934	Continuous disc 105 x 16/20 mm for Universal (12mm Segment)	10.00
4 2 608 602 460	Segmented disc - 110 x 16/20 mm for Universal (12mm Thick Segment)	6.50
2 608 603 329	Segmented disc 5", 125 x 22.2/25.4 mm for Universal (12mm Segment)	17.00
2 608 603 331	Segmented disc 7", 180 x 22.2/25.4 mm for Universal (12mm Segment)	31.00
2 608 603 332	Segmented disc 9", 230 x 22.2/25.4 mm for Universal (12mm Segment)	48.00
2 608 603 615	105 x 16/20 mm Fast Speed for Ceramic	11.00
2 608 642 952	Carbide Multi Wheel 110 mm x 16/20 mm	15.00
Diamond Disc for Concrete		
2 608 615 005	Diamond Disc for Concrete 300 x 25.4 / 27 mm	105.00
2 608 615 006	Diamond Disc for Concrete 350 x 25.4 / 27 mm	145.00
2 608 615 007	Diamond Disc for Concrete 400 x 25.4 / 27 mm	215.00
2 608 615 008	Diamond Disc for Concrete 450 x 25.4 / 27 mm	275.00
2 608 615 009	Diamond Disc for Concrete 500 x 25.4 / 27 mm	358.00
Diamond Disc for Asphalt		
2 608 615 015	Diamond Disc for Asphalt 300 x 25.4 / 27 mm	151.00
2 608 615 016	Diamond Disc for Asphalt 350 x 25.4 / 27 mm	191.00
2 608 615 017	Diamond Disc for Asphalt 400 x 25.4 / 27 mm	252.00
2 608 615 018	Diamond Disc for Asphalt 450 x 25.4 / 27 mm	327.00
2 608 615 019	Diamond Disc for Asphalt 500 x 25.4 / 27 mm	393.00
Flap Disc		
2 608 601 675	Flap Disc 4" P36 (Standard For Metal)	1.50
2 608 601 676	Flap Disc 4" P60 (Standard For Metal)	1.50
2 608 601 677	Flap Disc 4" P80 (Standard For Metal)	1.50
2 608 601 678	Flap Disc 4" P120 (Standard For Metal)	1.50
Zirconia Flap Disc (Standard for Inox) (EN 13743)		
2 608 603 357	Flap Disc 4" P40 (Standard For Inox)	3.20
2 608 603 358	Flap Disc 4" P60 (Standard For Inox)	3.00
2 608 603 359	Flap Disc 4" P80 (Standard For Inox)	3.00
2 608 603 360	Flap Disc 4" P120 (Standard For Inox)	3.00



Nibbler Accessories

	Part Number	Description	List Price (SGD)
For Model 1530 & GNA 2.0			
1	2 608 639 900	Universal Die-holder (Original with Tool)	92.60
2	021	Die-holder for corrugated materials	124.00
3	013	Straight & Curve Cutting Punch (Original with Tool)	30.90
4	016	Straight Cutting Punch	47.10
5	022	Cutting Punch for corrugated materials	42.00
6	902	Cutting Punch and Die-holder Set for corrugated materials	149.00
	025	Punch (GNA 3.5)	61.00
	2 607 010 025	Shear Blade Set (GSC 2.8 / 1506)	46.90

Foam Rubber Cutter Accessories

	Part Number	Description	List Price (SGD)
For Model 1575, GSG 300 & GSG 9.6 V			
7	2 607 018 010	Sawblade 130 mm (5 $\frac{1}{8}$ " T43A)	48.30
	011	Sawblade 200 mm (8.0" T43B)	59.40
	012	Sawblade 300 mm (11 $\frac{3}{4}$ " T43C)	68.10
	013	Sawblade 70 mm (2 $\frac{3}{4}$ " T43D)	43.70
8	2 608 135 020	Guide 130 mm (5 $\frac{1}{8}$ " T42A)	95.80
	021	Guide 200 mm (8.0" T42B)	106.30
	022	Guide 300 mm (11 $\frac{3}{4}$ " T42C)	113.70
	023	Guide 70 mm (2 $\frac{3}{4}$ " T42D)	67.20
	2 608 000 908	Foot Base	142.00

Jigsaw Accessories

9	2 607 010 079	Anti-Splintering Device (5 pieces) - Applicable for all Bosch Jigsaw	5.60
10	2 608 040 289	Parallel Guide (Replacement of 2 607 001 069)	11.00
11	1 609 200 265	Screwdriver for GST 60 / 80 PBE	4.60
	0 603 037 103	MT300 WP Jigsaw Table Complete	117.70
	0 603 037 102	MT300 Jigsaw Table w/o Angle and Parallel Guide	160.70

**BOSCH**

Invented for life



1



2



3



4



5



6

Jigsaw Accessories

Part Number	Description	List Price (SGD)
Jigsaw Blade Set		
1	2 607 010 146 Wood / 10 piece Set (T 101 B, T 101 DP, T 111 C, T 144 D, T 101 AO, T 119 BO)	19.40
2	147 Metal / 10 piece Set (T 118 A, T 118 B, T 118 G, T 127 D, T 111 C)	16.30
3	148 Metal & Wood / 10 piece Set (T 101 B, T 111 C, T 119 BO, T 118 A, T 127 D)	16.30

Jigsaw Blade for Wood (5 piece card)

	2 608 630 014	T 101 BR Reversed teeth, fine straight cut 4 ~ 30 mm	12.60
	030	T 101 B Fine straight cut 4 ~ 30 mm	10.50
4	2 608 630 031	T 101 AO Fine curved cut 2 ~ 20 mm	12.60
	032	T 101 D Fine straight cut 6 ~ 60 mm	10.50
	033	T 111 C Coarse quick cut 2 ~ 30 mm	6.30
	037	T 119 B Chipboard 2 ~ 30 mm, perspex 2 ~ 20 mm	10.00
5	040	T 144 D Straight quick cut 6 ~ 60 mm	10.00
	058	T 244 D Quick curved cut 6 ~ 60 mm	10.50
	2 608 637 944	T 344 D Thick construction wood, softwood (5-100 mm), Chipboards, Fibre boards, Plywood (3 piece/pkt)	7.90
	2 608 630 310	T 119 BO Tightest curved cut 2 ~ 20 mm	10.50
	2 608 637 527	T 101 DP Angle and parallel cut 6 ~ 60 mm - Replaced by T 144 DP	10.40
	2 608 633 A35	T 144 DP Parallel cut, soft wood & fibre board 5 ~ 50 mm	10.70
	2 608 637 590	T 301 CD Fine quick cut 4 ~ 60 mm	15.30
	2 608 633 528	T 234 X Wood Progressor	16.00
6	2 608 663 751	T 308 B Extra clean, straight cut, 91 2.2 mmXC, HCS	14.00
	569	T 308 BF Extra clean, straight cut, Hardwood 91 2.2 mmXC	43.70
	2 608 663 868	T 308 BO Extra-Clean for Wood, curve 91 2.2 mmXC, HCS	16.30
	2 608 636 640	T 308 BOF Extra-Clean for Hard Wood, curve 91 2.2 mmXC, BIM	32.70

* T 344 D - unit price for 3 piece/pack

**BOSCH**

Invented for life



Jigsaw Accessories

Part Number	Description	List Price (SGD)
Jigsaw Blade for Metal (5 piece card)		
2 608 631 010	T 101 A Aluminium 10 mm & ideal for Perspex 2 ~ 20 mm	19.50
012	T 118 G Straight cut, Thin materials 0.2 ~ 1.0 mm	9.80
013	T 118 A Straight cut, Very Thin materials 1.5 ~ 3.0 mm	5.50
014	T 118 B Straight cut, 3 ~ 6 mm	5.80
032	T 218 A Curve Cut, thin sheet metal (1-3 mm), HSS	11.00
017	T 127 D Straight quick cut, Aluminium 4 ~ 15 mm	15.00
030	T 227 D Curved cut, Aluminium 4 ~ 15 mm	16.00
319	T 318 A Straight cut, Sandwich materials 1.5 ~ 62 mm	18.00
404	T 318 B Straight curve cut, Sandwich materials 2 ~ 85 mm	18.90
2 608 638 473	T 123 X Metal Progressor (5's)	18.00
2 608 638 472	T 123 X Metal Progressor (3 piece/pkt)	12.00
Special - Tungsten Carbide (TC) tipped Jigsaw Blade (3 piece card)		
2 608 630 663	T 118 AHM (Straight cut, stainless steel 1.0 ~ 2.0 mm)	68.00
665	T 118 EHM (Straight cut, stainless steel 2.0 ~ 4.0 mm)	68.00
2 608 633 104	T 130 RIFF (Curved cut, ceramic & fibreglass 1 ~ 15 mm) - Replaced by T 130 RF	48.00
105	T 150 RIFF (Curved cut, ceramic & fibreglass 1 ~ 10 mm) - Replaced by T 150 RF	48.00
175	T 141 HM (Quick cut, fibreglass & chipboard 6 ~ 60 mm)	51.60
176	T 341 HM (Quick coarse cut, aerated concrete 6 ~ 80 mm)	67.20
2 608 635 177	T 113 A (Leather, carpet, polystyrene 1 ~ 25 mm)	29.70
2 608 636 187	T 313 AW Special for soft Material, carton, polystyrene, carpet, leather, rubber (< 100 mm). Length 126 mm. (3 piece/pkt)	36.00
Jigsaw Blade for Plastic		
2 608 667 444	T 102D Jigsaw Blade for PP (5 piece)	12.50
1 2 608 667 446	T 102H Jigsaw Blade for PVC (5 piece)	12.50
2 608 667 448	T 302H Jigsaw Blade for PVC (5 piece - long)	19.00
2 2 608 636 781	T 102BF Jigsaw Blade for PMMA (5 piece)	28.00
2 608 667 449	T 108BHF Jigsaw Blade for Carbon Fiber (3 piece)	66.00
3 2 608 667 450	T 301CHM Jigsaw Blade for Carbon Fiber (3 piece)	101.00



Jigsaw Accessories

Part Number	Description	List Price (SGD)
Bi-Metal Jigsaw Blades for various materials (5 piece card)		
2 608 634 238	T 127 DF (Quick straight cut, ideal for aluminium 4 ~ 15 mm) - Replaced by T 127 D	23.50
503	T 118 BF (Thick material, curved cut, perspex 3 ~ 20mm)	12.20
1 505	T 118 AF (Straight cut, non-ferrous metals 2 ~ 10 mm)	18.00
567	T 144 DF (Quick straight cut, wood + nail 6 ~ 60 mm)	21.40
234	T 101 BF (Fine straight cut, blockboard 4 ~ 30 mm)	22.70
2 2 608 636 420	T 118 EFS (Stainless steel 1.5 ~ 4.0 mm)	26.00
3 442	T 118 GFS (Stainless steel 0.5 ~ 1.5 mm)	26.00
4 2 608 634 993	T 345 XF Universal Progressor (3 pcs/pkt)	16.00
For Makita (5 piece card)		
5 2 608 668 593	MA 118 A (3pcs) & MA 118 B (2pcs)	20.50
6 2 608 667 854	MA 111 C (3pcs) & MA 101 B6 (2pcs)	16.00

**BOSCH**

Invented for life

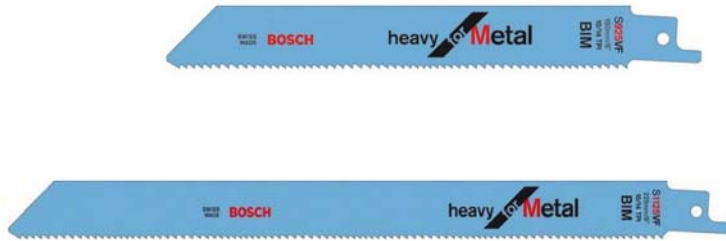

Sabre Saw Blade & Reciprocating Saw Blade

Model	Part Number	Application	Description	List Price (SGD)
For Model PFZ 600 E, GSA 1100 PE, GSA 1200 PE & GSA 1200 E (5 piece pack)				
S 922EF	2 608 656 015	Flexible for metal	Thin cut, metal (1.5 ~ 4 mm), closed pipe/profile (5 ~ 100 mm). 18 TPI (BiM/milled) x 150 mm	20.00
S 1122EF	020	Flexible for metal	Flush cut, thin metal (1.5 ~ 4 mm), closed pipe/profile (5 ~ 175 mm). 18 TPI (BiM/milled) x 225 mm	27.80
S 922BF	014	Flexible for metal	Fast cut, metal (3 ~ 8 mm), closed pipe/profile (10 ~ 100 mm). 14 TPI (BiM/milled) x 150 mm	20.00
S 1122BF	019	Flexible for metal	Flush quick cut, thick metal (3 ~ 8 mm), closed pipe/profile (10 ~ 175 mm). 14 TPI (BiM/milled)	23.80
S 1122VF	2 608 654 981	Flexible for wood/metal	Flush cut, wood/metal (5 ~ 175 mm), alu profile (3 ~ 10 mm), plastic profile (3 ~ 175 mm). 10 ~ 14 TPI (BiM/milled) x 225 mm	34.10
S 1222VF	2 608 656 022	Flexible for wood/metal	Flush cut, wood/metal (5 ~ 250 mm), alu profile (3 ~ 10 mm), plastic profile (3 ~ 250 mm). 10 ~ 14 TPI (BiM/milled) x 300 mm	32.50
S 3456XF	2 608 654 406	Progressor for wood/metal	Power cut, wood/metal (5 ~ 150 mm), alu profile (3 ~ 18 mm), fibre glass (5 ~ 150 mm). 6 ~ 12 TPI (BiM/milled)	31.20
S 611DF	2 608 656 271	Heavy Duty for wood/metal	Plunge cut, wood with nails / metal, chipboard (10 - 100 mm), plastic profiles (diameter 5 - 100 mm), plastics / glass fibre plastic, solid (8 - 50 mm), window frames: wood + metal x 150 mm. (2 pieces)	16.70
S 711DF	2 608 656 260	Heavy Duty for wood/metal	Curve cut, wood/metal (10 ~ 100 mm) fibre glass (8 ~ 50 mm). 6 TPI (BiM, milled)	22.70
S 1411DF	2 608 654 834	Heavy Duty for wood/metal	Fast cut, wood/metal & aerated concrete (10 ~ 250 mm), fibre glass (5 ~ 60 mm). 6 TPI (BiM/milled) x 300mm. (2 pieces)	17.50
S 617K	2 608 650 677	Basic for wood	Curve cut, coarse/green wood (20 ~ 100 mm). 3 TPI (HCS/milled)	17.40
S 1111K	678	Basic for wood	Rough cut, coarse wood (20 ~ 175 mm). 3 TPI (HCS/milled)	20.80

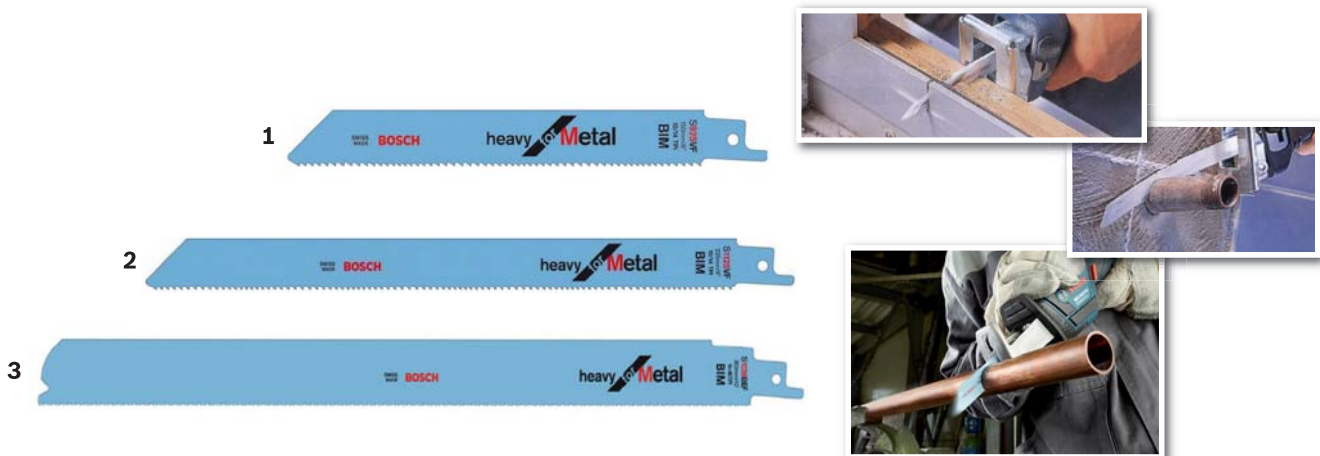

Sabre Saw Blade & Reciprocating Saw Blade

Model	Part Number	Application	Description	List Price (SGD)
For Model PFZ 600 E, GSA 1100 PE, GSA 1200 PE & GSA 1200 E (5 piece pack)				
S 644D	673	Top for wood	Clean cut, construction wood (6 ~ 100 mm). 6 TPI (HCS/ground)	14.00
S 1531L	613	Top for wood	Fast cut, coarse/green wood (15 ~ 190 mm). 5 TPI (HCS/ground) x 240mm. (2 pieces)	13.20
S 628DF	2 608 656 263	For plaster	Plunge cut, plaster board (8 ~ 100 mm). 6 TPI (BiM/milled)	26.30
S 1127BEF	2 608 657 524	Heavy Duty for metal	Straight & clean cut (225 x 25 x 1.1 mm) BiM (3 ~ 8 mm), metal pipe/channel/profile (<175 mm). 14 + 18 TPI (1.4 + 1.8 mm)	30.00
S 522 EHM	2 608 653 096	Special for INOX Stainless steel	INOX metal plates (2 - 4 mm), INOX profiles (diameter 2 - 50 mm). glass fibre plastic/epoxy (2 - 15 mm), 18 TPI (1.4 mm, TC / ground edge) x 115mm. metal: stroke rate reduction, cooling!, work without pendulum action. (1 piece)	20.00
S 1130RIFF	2 608 650 969	Special for Cast /Brick	Cast steel pipes (max. diameter 6"), brick, red (10 - 175 mm), glass fibre plastic/eboxy (3 - 175 mm). G30 (TC coated) x 225 mm x 1.5 mm. (2 pieces)	39.80
1 S 925 VF	2 608 657 407	Heavy Duty for Metal	Medium-thick to thick sheet metals (2-10 mm), thin-walled and thick-walled pipes and profiles (<100 mm) (10/14 TPI x 150 mm) (BIM, vario-pitched teeth)	20.00
2 S 1125 VF	2 608 657 408	Heavy Duty for Metal	Medium-thick to thick sheet metals (2-10 mm), thin-walled and thick-walled pipes and profiles (<175 mm) (10/14 TPI x 225 mm) (BIM, vario-pitched teeth)	25.00
3 S 1227 BEF	2 608 658 147	Heavy Duty for Metal	Medium-thick to thick sheet metals (3-8 mm), thin-walled closed and open profiles and pipes (<250 mm) (14/18 x 300 mm) (BIM, patented 2x2 Tooth Geometry)	32.00
S 522 EF	2 608 656 012	Flexible for Metal	(100 mm x 19 x 0.9) for GAS 10.8 V-LI 5 pcs pack	19.50
S 511 DF	2 608 657 723	Flexible for Wood & Metal	(100 mm x 19 x 0.9) for GAS 10.8 V-LI 5 pcs pack	19.50

**BOSCH**

Invented for life

**1****2****3**

Part Number	Description	List Price (SGD)
1 2 607 017 473	15 pcs Mixed Bit Set (1/4" Shank)	119.00
2 607 017 470	6 pcs Trim & Edging Bit Set (1/4" Shank)	53.00
2 607 017 467	6 pcs Straight Bit Set (1/4" Shank)	48.50

Circular Saw Accessories

Part Number	Description	Bore Size	Reduction Rings	List Price (SGD)
For GKS 6 1/2", GKS 7 1/4", GKS 165, GKS 190 & GKS 235				
2 2 607 001 219	Parallel Guide			19.00
1 619 P06 204	Dust Adapter (GKS 190)			4.00
2 608 000 563	Dust Adaptor (GKS 7000 / GKS 600)			5.00

Circular Saw Blade (Wood Cutting) Expert for Wood

3 2 608 642 971	6 1/8" 160 x 2.0 / 1.4 x 25.4 x 40 TCT	1"	20/19/16/5/8" (Replacement of 2608640843)	17.50
2 608 642 972	6 1/8" 160 x 2.0 / 1.4 x 25.4 x 60 TCT	1"	20/19/16/5/8" (Replacement of 2608640844)	21.40
2 608 642 983	7 1/4" 184 x 2.0 / 1.4 x 25.4 x 30 TCT	1"	20/19/16/5/8" (Replacement of 2608640861)	19.90
2 608 643 048	7 1/4" 184 x 1.6 / 1.1 x 20 x 40 TCT	20	16/5/8" (Replacement of 2608640997)	21.40
2 608 642 984	7 1/4" 184 x 2.0 / 1.4 x 25.4 x 40 TCT	1"	20/19/16/5/8" (Replacement of 2608640862)	22.10
2 608 642 985	7 1/4" 184 x 2.0 / 1.4 x 25.4 x 60 TCT	1"	20/19/16/5/8" (Replacement of 2608640863)	28.40
2 608 642 999	9 1/4" 235 x 2.2 / 1.5 x 30 x 40 TCT	30	1"/25 (Replacement of 2608640894)	30.20
2 608 643 000	9 1/4" 235 x 2.2 / 1.5 x 30 x 60 TCT	30	1"/25 (Replacement of 2608640895)	35.10
2 608 643 009	10" 254 x 2.5 / 1.8 x 30 x 80 TCT	30	1"/25 (Replacement of 2608640909)	51.10
2 608 643 010	10" 254 x 2.5 / 1.8 x 30 x 100 TCT	30	1"/25 (Replacement of 2608640910)	57.50
2 608 643 005	10" 254 x 2.5 / 1.8 x 1" x 120 TCT	1"	20/16/5/8" (Replacement of 2608640905)	50.70
2 608 643 024	12" 305 x 2.5 / 1.8 x 30 x 40 TCT	30	1"/25/20 (Replacement of 2608640920)	58.50
2 608 643 026	12" 305 x 2.5 / 1.8 x 30 x 80 TCT	30	1"/25/20 (Replacement of 2608640922)	66.30
2 608 643 027	12" 305 x 2.5 / 1.8 x 30 x 100 TCT	30	1"/25/20 (Replacement of 2608640923)	85.20
2 608 643 033	14" 356 x 3.2 / 2.2 x 30 x 60 TCT	30	1"/25/20 (Replacement of 2608640931)	68.20
2 608 643 035	14" 356 x 3.2 / 2.2 x 30 x 100 TCT	30	1"/25/20 (Replacement of 2608640933)	105.30
2 608 643 046	6 1/4" 160 x 1.6 / 1.1 x 20 x 40 TCT	20	16/5/8" (Replacement of 2608640992)	19.50
2 608 643 071	85 x 15 mm x 20 TCT (For GKS 10.8 V-LI)			14.90

**BOSCH**

Invented for life



3



4



5

Circular Saw Accessories

Part Number	Description	Reduction Rings	List Price (SGD)
Circular Saw Blade Eco Range			
2 608 644 319	110 x 1.8 x 20 mm (40 T) Multimaterial	No	7.80
2 608 644 317	180 x 2.6 x 25.4 mm (40 T) Wood	20 mm	12.00
2 608 644 318	180 x 2.6 x 25.4 mm (60 T) Wood	20 mm	14.50
2 608 644 305	230 x 2.8 x 25.4 mm (40 T) Wood	25/20 mm	25.00
2 608 644 306	230 x 2.8 x 25.4 mm (60 T) Wood	25/20 mm	29.00
Multi Material Circular Saw Blade (Long Life 50% extra)			
Long Life Multi Material for Non Ferrous Metal Cutting (aluminium)			
3 2 608 642 202	Circular Saw Blade (10" X 100T)	30 mm X (25 mm & 1")	58.00
203	Circular Saw Blade (10" X 120T)	30 mm X (25 mm & 1")	63.00
209	Circular Saw Blade (12" X 100T)	30 mm X (20 mm, 25 mm & 1")	79.00
210	Circular Saw Blade (12" X 120T)	30 mm X (20 mm, 25 mm & 1")	90.00
213	Circular Saw Blade (14" X 100T)	30 mm X (20 mm, 25 mm & 1")	99.00
214	Circular Saw Blade (14" X 120T)	30 mm X (20 mm, 25 mm & 1")	109.00
Circular Saw Blade (Metal Cutting)			
4 2 608 643 060	Circular Saw Blade for GCD 12 JL (305 x 25.4 x 2.6 mm x 60 TCT)		174.00
2 608 643 061	Circular Saw Blade for GCD 12 JL (305 x 25.4 x 2.6 mm x 80 TCT)		201.00
2 608 644 225	Circular Saw Blade for GKM 18 V-LI (136 x 20 x 1.6 mm x 30 TCT)		47.00
Cordless Circular Saw Blade			
2 608 837 721	Cordless Circular Saw Blade for Wood (216 x 1.7/1.2 x 30 mm x T24)		35.00
2 608 837 723	Cordless Circular Saw Blade for Wood (216 x 1.7/1.2 x 30 mm x T48)		47.00
2 608 837 776	Cordless Circular Saw Blade for Wood (216 x 2.2/1.6 x 30 mm x T64)		60.00
Band Saw Blade (Metal Cutting) for GCB 18V-LI			
5 2 608 649 000	Band Saw Blade (18T) (2pcs)		45.00
2 608 649 001	Band Saw Blade (24T) (2pcs)		45.00

**BOSCH**

Invented for life

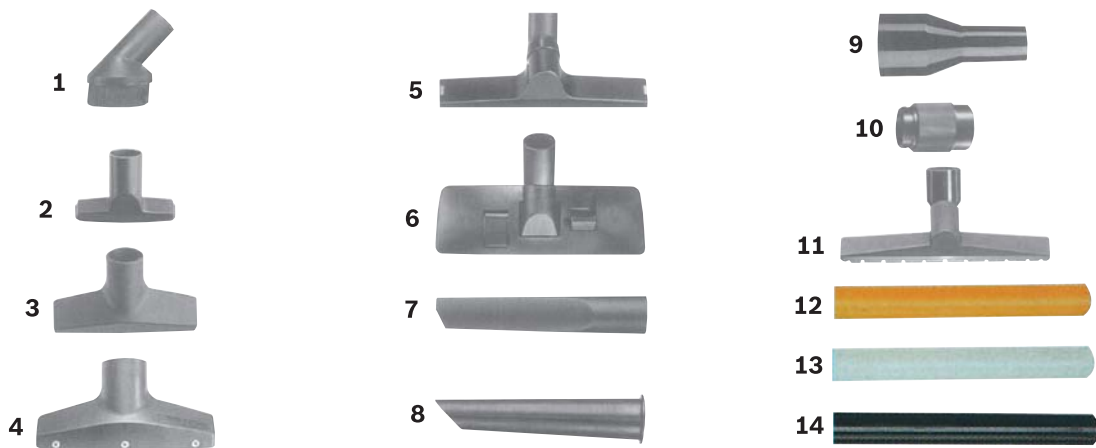

Vacuum Cleaner Accessories

Part Number	Description	List Price (SGD)
Dust Bag (Paper Filter Bag)		
2 605 411 061	5 pieces (For Model PAS 11-25)	45.10
150	5 pieces (For Model PAS 11-21 / GAS 11-21)	45.10
Filter (Single piece)		
2 607 432 001	Bellows Filter (For Model PAS 1000 / 11-25) - Replacing 1 609 201 636	59.20
013	Textile Filter (For Model PAS 11-21 GAS 11-21)	35.20
Flexible Hose		
2 607 002 149	35 mm x 3.0 meter (For Model PAS 11-21, GAS 11-21)	35.20
2 607 002 150	35 mm x 5.0 meter (For Model PAS 11-21, GAS 11-21)	46.00
Extension Pipe (2 piece)		
2 607 000 162	35 mm x 0.5 meter (For Model PAS 1000 / 11-25 / 11-21)	59.20
Nozzle (35 mm Fitting)		
1 1 609 390 481	Small Round Brush	11.30
2 2 607 000 166	Small Floor Nozzle	19.70
3 170	Coarse Dirt Nozzle	25.40
4 168	Scraper Nozzle	41.50
5 1 609 390 478	Multi-purpose Nozzle (with 3 inserts)	54.90
6 1 609 201 230	Floor Nozzle	41.50
7 2 607 000 165	Crevice Nozzle	11.30
8 1 609 201 229	Rubber Nozzle	22.60
Reducing Nozzle		
9 1 609 200 976	49 mm to 35 mm	8.50
10 1 609 390 474	49 mm / 35 mm / 19 mm	14.60
Nozzle (49 mm Fitting)		
11 1 609 200 970	Floor Nozzle	40.40

Glue Gun Accessories

For Model PKP 18 & GKP 200 CE

12 1 609 201 217	Yellow 125 g (For wood, cardboard, packaging)	7.60
13 219	Transparent 125 g (For glass, ceramics, plastic, metal)	6.80
220	Transparent 500 g (For glass, ceramics, plastic, metal)	21.10
396	Transparent 500 g (For all materials)	20.20
14 221	Black 125 g (For seals, carpet)	7.80

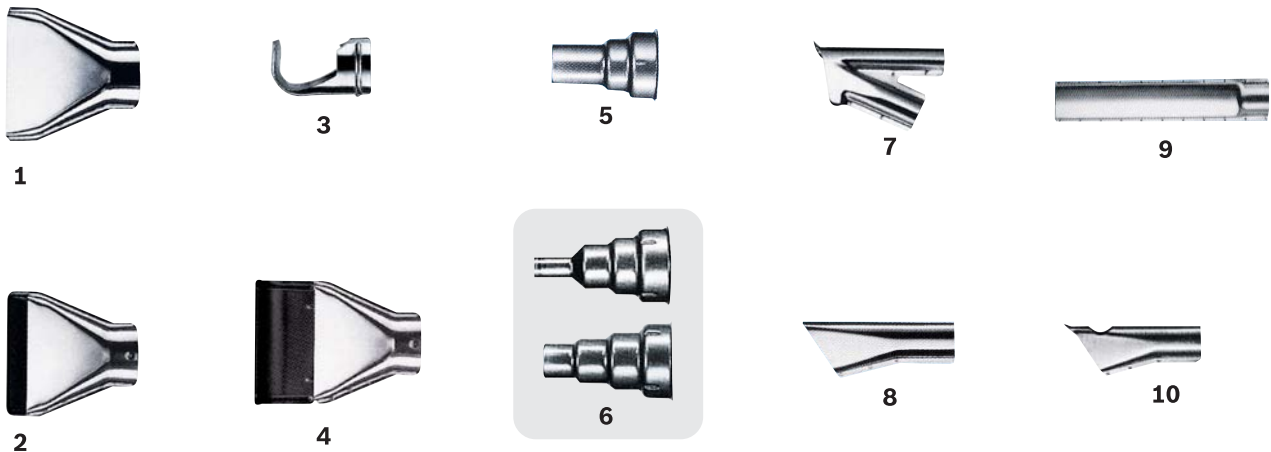

Hot Air Gun Accessories

Part Number	Description	List Price (SGD)
For Model PHG 520, PHG 530 2, PHG 600 CE, PHG 600 2 CE, GHG 600 CE, GHG 650 LCE, GHG 600-3 & GHG 600 DCE		
1 1 609 390 451	Surface Nozzle (75 mm)	21.60
1 609 201 795	Surface Nozzle (50 mm)	4.40
2 1 609 390 452	Glass Nozzle (75 mm)	21.60
1 609 201 796	Glass Nozzle (50 mm)	4.40
3 1 609 390 453	Reflector Nozzle	21.60
4 1 609 201 751	Angle Nozzle (80 mm)	7.10

Only for PHG 600 CE, PHG 630 2CE, GHG 600 CE, GHG 650 LCE & GHG 630 DCE

5 1 609 201 648	Reduction Nozzle (20 mm)	16.10
6 647	Reduction Nozzle (14 mm)	18.20
797	Reduction Nozzle (9 mm)	22.30
7 798	Welding / Rods Nozzle - In conjunction with 1 609 201 797	39.50
8 799	Slot Nozzle - In conjunction with 1 609 201 797	3.30
9 800	Cutting Nozzle - In conjunction with 1 609 201 797	4.30
10 801	Welding / Wire Nozzle - In conjunction with 1 609 201 797	3.30

Bench Grinder Accessories

For Model GBG 8

2 608 600 111	200 x 25 x 32 mm (Coarse / Grit 36)	65.10
112	200 x 25 x 32 mm (Fine / Grit 60)	60.60
106	200 x 25 x 32 mm (Silicon carbide)	71.80

**BOSCH**

Invented for life

**1**

Belt Sander Accessories

Part Number Description

List Price
(SGD)**For Model GBS 100 A****Sanding Belt for Wood and Metal (10 piece pack)**

Part Number	Description	List Price (SGD)
1 2 608 606 150	Sanding Belt 100 x 620 mm (G 24) - Replacing 2 607 018 171	62.10
152	Sanding Belt 100 x 620 mm (G 60) - Replacing 2 607 018 163	51.70
153	Sanding Belt 100 x 620 mm (G 80) - Replacing 2 607 018 164	30.50
154	Sanding Belt 100 x 620 mm (G 100) - Replacing 2 607 018 165	49.40
155	Sanding Belt 100 x 620 mm (G 150) - Replacing 2 607 018 166	49.40
156	Sanding Belt 100 x 620 mm (G 220) - Replacing 2 607 018 167	49.40
157	Sanding Belt 100 x 620 mm (G 280) - Replacing 2 607 018 168	49.40
158	Sanding Belt 100 x 620 mm (G 320) - Replacing 2 607 018 169	49.40
159	Sanding Belt 100 x 620 mm (G 400) - Replacing 2 607 018 170	49.40
3 601 010 509	Graphite Asbestos Sheet	8.60

For Model PBS 75, GBS 75**Sanding Belt for Wood and Metal (3 piece pack)**

2 608 606 069	Sanding Belt 75 x 533 mm (G 40) - Replacing 1 609 201 384	13.90
070	Sanding Belt 75 x 533 mm (G 60) - Replacing 1 609 201 385	13.90
071	Sanding Belt 75 x 533 mm (G 80) - Replacing 1 609 201 386	13.90
072	Sanding Belt 75 x 533 mm (G 100) - Replacing 1 609 201 387	13.90
073	Sanding Belt 75 x 533 mm (G 150) - Replacing 1 609 201 388	13.90
074	Sanding Belt 75 x 533 mm (G 220) - Replacing 1 609 201 389	13.90
075	Sanding Belt 75 x 533 mm (G 280) - Replacing 1 609 301 390	13.90
076	Sanding Belt 75 x 533 mm (G 320) - Replacing 1 609 301 391	13.90
077	Sanding Belt 75 x 533 mm (G 400) - Replacing 1 609 301 392	13.90
2 601 098 043	Fine Sanding Plate with Graphite Base	5.70

For Model GPO 950

1 619 PB1 954	Velco Rubber Pad (165 mm)	7.80
1 619 PB1 966	Sponge (170 mm)	6.70

**BOSCH**

Invented for life

**Fast and effortless drilling**

The “Inner-middle-outer” tip combination minimizes friction and heat for higher cutting performance.

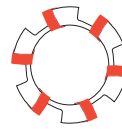
**High sharpness tip**

Optimized tip geometry leads to extra cutting rate for annular drilling.

**TCT Annular Cutter**

Part Number	Description	List Price (SGD)
NEW! TCT Annular Cutter		
2 608 577 495	TCT Annular Cutter, 14 x 50 mm	64.00
496	TCT Annular Cutter, 16 x 50 mm	64.00
497	TCT Annular Cutter, 18 x 50 mm	64.00
498	TCT Annular Cutter, 20 x 50 mm	64.00
499	TCT Annular Cutter, 22 x 50 mm	70.00
500	TCT Annular Cutter, 24 x 50 mm	70.00
501	TCT Annular Cutter, 26 x 50 mm	74.00
502	TCT Annular Cutter, 28 x 50 mm	74.00
503	TCT Annular Cutter, 30 x 50 mm	74.00
504	TCT Annular Cutter, 32x 50 mm	90.00
505	TCT Annular Cutter, 35 x 50 mm	90.00
506	TCT Annular Cutter, 40 x 50 mm	100.00
509	PIN, PL 6050 (6.34 x 106 mm)	8.00
510	PIN, PL 8050 (8 x 106 mm)	8.00

**BOSCH**

Invented for life

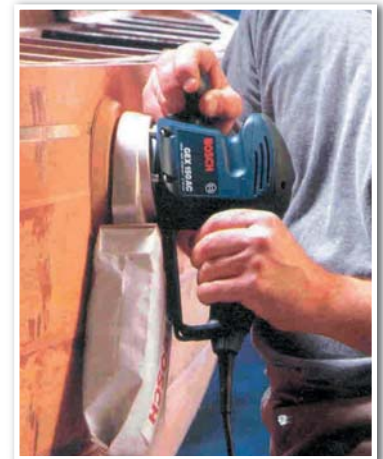
**1****2****3****4**

Multi Sander Accessories

	Part Number	Description	List Price (SGD)
Sanding Disc for Wood and Paint (5 piece pack)			
1	2 608 605 067	Sanding Paper x 125 mm (G 40)	5.20
	068	Sanding Paper x 125 mm (G 60)	5.20
	069	Sanding Paper x 125 mm (G 80)	5.20
	070	Sanding Paper x 125 mm (G 100)	5.20
	071	Sanding Paper x 125 mm (G 120)	5.20
	072	Sanding Paper x 125 mm (G 180)	5.20
	073	Sanding Paper x 125 mm (G 240)	5.20
	074	Sanding Paper x 125 mm (G 320)	5.20
	075	Sanding Paper x 125 mm (G 400)	5.20
	2 608 601 169	Rubber Pad for GEX 270 A/AE	16.30
	2 609 100 900	Rubber Pad for GEX 125-1 AE (SP)	19.50
	2 608 601 062	Rubber Pad, standard (125 mm) (PEX 12, PEX 400)	16.30
	2 605 411 145	Micro Filter Box (PEX, GEX 270A, GBS 75A)	11.70
125 mm Sanding Disc (Wood & Metal)			
2	2 608 621 577	G40 125 mm Sanding Disc (5pcs pack)	3.50
	578	G60 125 mm Sanding Disc (5pcs pack)	3.50
	579	G80 125 mm Sanding Disc (5pcs pack)	3.50
	580	G120 125 mm Sanding Disc (5pcs pack)	3.50
	581	G180 125 mm Sanding Disc (5pcs pack)	3.50
	582	G240 125 mm Sanding Disc (5pcs pack)	3.50
	583	G320 125 mm Sanding Disc (5pcs pack)	3.50
3	2 608 610 001	Lambswool Bonnet (130 mm)	10.60
4	2 608 613 005	Polishing Sponge (130 mm)	10.60
	2 608 605 115	Sanding Disc (Black Stone) G80	5.20
	117	Sanding Disc (Black Stone) G120	5.20
	120	Sanding Disc (Black Stone) G320	5.20
	123	Sanding Disc (Black Stone) G1200	5.20
	002	Sanding Disc (White Paint) G80	5.20
	004	Sanding Disc (White Paint) G120	5.20
	006	Sanding Disc (White Paint) G240	5.20

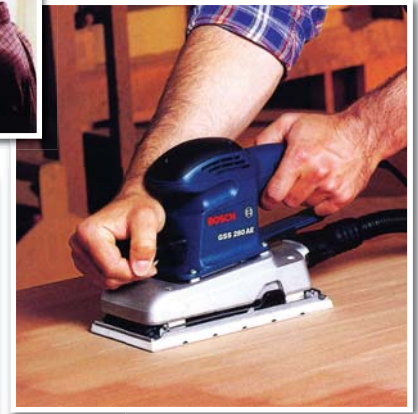
1

2

Multi Sander Accessories

Part Number	Description	List Price (SGD)
For Model GSS 180 A & GSS 230 (Wood Top)		
1	2 608 605 226 Sanding sheet c/w hole G60 x 10's	10.10
	228 Sanding sheet c/w hole G120 x 10's	10.10
	230 Sanding sheet c/w hole G240 x 10's	10.10
	910 Sanding sheet c/w hole G320 x 10's	10.10

For Model GSS 280 A (Velcro Type)		
	2 608 605 266 Sanding sheet c/w hole G60 x 10's	18.00
	268 Sanding sheet c/w hole G120 x 10's	18.00
	759 Sanding sheet c/w hole G320 x 10's	18.00

Multi Purpose Hand Sanding Sheet		
2	2 608 621 309 G60 Hand Sanding Sheet (100pcs pack)	35.00
	310 G80 Hand Sanding Sheet (100pcs pack)	35.00
	311 G100 Hand Sanding Sheet (100pcs pack)	35.00
	312 G120 Hand Sanding Sheet (100pcs pack)	35.00
	313 G150 Hand Sanding Sheet (100pcs pack)	35.00
	314 G180 Hand Sanding Sheet (100pcs pack)	35.00
	315 G220 Hand Sanding Sheet (100pcs pack)	35.00
	316 G240 Hand Sanding Sheet (100pcs pack)	35.00
	317 G320 Hand Sanding Sheet (100pcs pack)	35.00
	318 G400 Hand Sanding Sheet (100pcs pack)	35.00
	319 G500 Hand Sanding Sheet (100pcs pack)	35.00
	320 G600 Hand Sanding Sheet (100pcs pack)	35.00
	321 G800 Hand Sanding Sheet (100pcs pack)	35.00
	322 G1000 Hand Sanding Sheet (100pcs pack)	35.00
	323 G1200 Hand Sanding Sheet (100pcs pack)	35.00

**BOSCH**





Invented for life

**1****2****3****4****5**

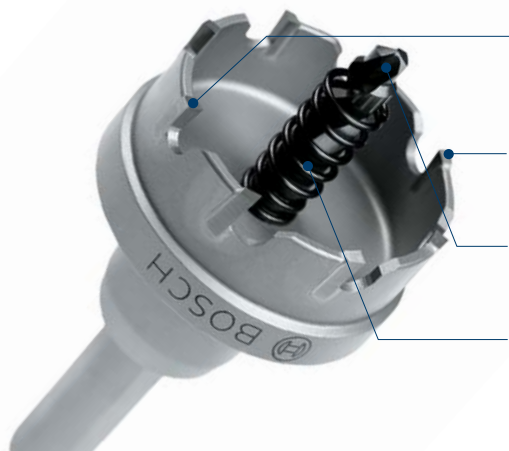
HSS Bi-Metal Holesaw

Part Number	Description	Diameter (mm/inch)	List Price (SGD)
1 2 608 580 396	Bi-Metal Holesaw	14 mm	5.00
2 608 580 397	Bi-Metal Holesaw	16 mm	5.20
2 608 580 398	Bi-Metal Holesaw	17 mm	5.40
2 608 580 399	Bi-Metal Holesaw	19 mm	5.80
2 608 580 400	Bi-Metal Holesaw	20 mm	6.00
2 608 580 401	Bi-Metal Holesaw	21 mm	6.30
2 608 580 402	Bi-Metal Holesaw	22 mm	6.50
2 608 580 403	Bi-Metal Holesaw	24 mm	6.70
2 608 580 404	Bi-Metal Holesaw	25 mm	6.90
2 608 580 405	Bi-Metal Holesaw	27 mm	7.40
2 608 580 406	Bi-Metal Holesaw	29 mm	7.90
2 608 580 407	Bi-Metal Holesaw	30 mm	8.10
2 608 580 408	Bi-Metal Holesaw	32 mm	8.60
2 608 580 409	Bi-Metal Holesaw	33 mm	8.80
2 608 580 410	Bi-Metal Holesaw	35 mm	9.00
2 608 580 411	Bi-Metal Holesaw	37 mm	10.20
2 608 580 412	Bi-Metal Holesaw	38 mm	10.30
2 608 580 413	Bi-Metal Holesaw	40 mm	10.50
2 608 580 414	Bi-Metal Holesaw	41 mm	10.80
2 608 580 415	Bi-Metal Holesaw	43 mm	11.30
2 608 580 416	Bi-Metal Holesaw	44 mm	11.50
2 608 580 417	Bi-Metal Holesaw	46 mm	12.00
2 608 580 418	Bi-Metal Holesaw	48 mm	12.50
2 608 580 419	Bi-Metal Holesaw	51 mm	13.00
2 608 580 420	Bi-Metal Holesaw	52 mm	14.30
2 608 580 421	Bi-Metal Holesaw	54 mm	14.80
2 608 580 422	Bi-Metal Holesaw	56 mm	15.00
2 608 580 423	Bi-Metal Holesaw	57 mm	15.20
2 608 580 424	Bi-Metal Holesaw	59 mm	15.70
2 608 580 425	Bi-Metal Holesaw	60 mm	16.10
2 608 580 426	Bi-Metal Holesaw	64 mm	16.70
2 608 580 427	Bi-Metal Holesaw	65 mm	16.90
2 608 580 428	Bi-Metal Holesaw	67 mm	17.40
2 608 580 429	Bi-Metal Holesaw	68 mm	17.60
2 608 580 430	Bi-Metal Holesaw	70 mm	18.20
2 608 580 431	Bi-Metal Holesaw	73 mm	19.70
2 608 580 432	Bi-Metal Holesaw	76 mm	20.20
2 608 580 433	Bi-Metal Holesaw	79 mm	20.70
2 608 580 434	Bi-Metal Holesaw	83 mm	21.20
2 608 580 435	Bi-Metal Holesaw	86 mm	21.60
2 608 580 436	Bi-Metal Holesaw	89 mm	23.10
2 608 580 437	Bi-Metal Holesaw	92 mm	24.90
2 608 580 438	Bi-Metal Holesaw	95 mm	25.70
2 608 580 439	Bi-Metal Holesaw	98 mm	26.00
2 608 580 440	Bi-Metal Holesaw	102 mm	26.90
2 608 580 441	Bi-Metal Holesaw	105 mm	27.90
2 608 580 442	Bi-Metal Holesaw	108 mm	28.60
2 608 580 443	Bi-Metal Holesaw	111 mm	29.60
2 608 580 444	Bi-Metal Holesaw	114 mm	30.60
2 608 580 445	Bi-Metal Holesaw	121 mm	35.20
2 608 580 446	Bi-Metal Holesaw	127 mm	36.60
2 608 580 447	Bi-Metal Holesaw	140 mm	39.10
2 608 580 448	Bi-Metal Holesaw	152 mm	42.00
2 2 609 390 512	8 mm hex adapter (for diameter 14-32mm)	Replaced by 2 609 390 588	11.30
3 2 609 390 588	11 mm hex adapter (for diameter 14-32mm)		11.90
2 609 390 034	11 mm hex adapter (for diameter 33-152mm)		19.30
4 2 609 390 035	SDS plus adapter (for diameter 14-32mm)		16.60
5 2 609 390 036	SDS plus adapter (for diameter 33-152mm)		23.60



- 
Tungsten Carbide Technology
 Increased hardness due to highest quality carbide grit with extra fine pre-alloyed powders for an extremely long lifetime. No teeth breakage due to excellent brazing process.
- 
Optimized teeth design
 Extremely sharp, thin cutting edges and ideal gullet design guarantee very fast cutting speed and efficient chip removal.
- 
Stepped pilot drill bit
 Prevents tip impact in order to protect the supreme quality carbide tipped teeth.
- 
Ejection spring
 Guarantees automatic disc ejection for efficient continuous cutting.



Indent TCT Holesaw

Part Number	Description	List Price (SGD)
2 608 594 005	TCT Hole Saw, 16 mm*	28.00
008	TCT Hole Saw, 19 mm*	28.00
009	TCT Hole Saw, 20 mm*	28.00
011	TCT Hole Saw, 22 mm*	33.00
014	TCT Hole Saw, 25 mm*	33.00
015	TCT Hole Saw, 26 mm*	34.00
017	TCT Hole Saw, 28 mm*	34.00
019	TCT Hole Saw, 30 mm*	34.00
021	TCT Hole Saw, 32 mm*	38.00
024	TCT Hole Saw, 35 mm*	38.00
027	TCT Hole Saw, 38 mm*	40.00
058	TCT Hole Saw, Center Drill Bit*	7.00
059	TCT Hole Saw, Spring (5pcs)*	0.50
060	TCT Hole Saw, Screw (10pcs)*	0.40

Planer Accessories

For GHO 10-82, GHO 6500

2 608 838 999	TC Planer Knife (set)	18.50
2 607 000 193	HSS Planer Knife (set)	18.50

Mini Router / Trimmer Accessories

For GMR 1, GKF 550

2 607 017 467	6 pcs Straight Bit Set (1/4" Shank)	48.50
2 607 017 470	6 pcs Trim & Edging Set (1/4" Shank)	53.00
2 607 017 473	15 pcs Mixed Bit Set (1/4" Shank)	119.00

*On Indent Basis.

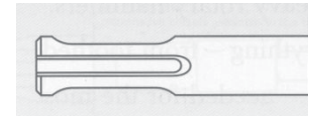
SDS-Plus shank

3

SDS Plus Drill Bit

Part Number	Description	List Price (SGD)
SDS Plus Drill Bit (Plus 1) Previously known as S3		
1 2 608 680 257	4 x 50/110	1.25
258	5 x 50/110	1.15
259	5 x 100/160	1.50
260	5.5 x 50/110	1.40
261	5.5 x 100/160	1.50
262	6 x 50/110	1.40
263	6 x 100/160	1.50
264	6 x 150/210	2.25
265	6.5 x 50/110	1.50
266	6.5 x 100/160	1.65
267	7 x 50/110	1.50
268	7 x 100/160	1.65
269	8 x 50/110	1.50
270	8 x 100/160	1.65
271	8 x 150/210	2.25
272	18 x 200/260	2.85
273	10 x 100/160	1.75
274	10 x 150/210	2.35
275	10 x 200/260	3.00
276	10 x 400/460	5.00
277	12 x 100/160	1.75
278	12 x 150/210	2.60
279	12 x 200/260	3.60
280	12 x 400/460	5.60
2 608 588 059	13 x 100/160	2.60
281	14 x 100/160	2.60
282	14 x 150/210	3.25
283	14 x 200/260	4.10
284	14 x 400/460	5.85
285	16 x 150/210	3.75
286	16 x 250/310	5.00
287	16 x 400/460	7.60
288	18 x 200/260	5.00
289	18 x 400/460	8.75
290	20 x 200/260	7.60
291	20 x 400/460	10.15
292	22 x 200/260	8.75
293	22 x 400/460	11.40
294	25 x 200/260	10.15
295	25 x 400/460	14.00
2 608 579 119	SDS Plus 1 (5 pcs Set) [5.6 x 110, 6.8, 10 x 160]	7.80

Drilling Accessories - Concrete (for SDS-Plus Rotary Hammers)

**BOSCH**

Invented for life

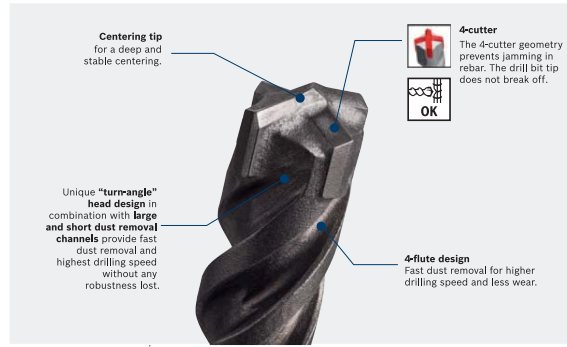
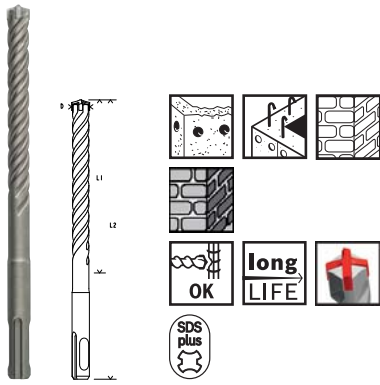

SDS Plus Drill Bit

Part Number	Description	List Price (SGD)
SDS Plus 5X		
2 608 833 771	5 x 50 x 110 mm	3.80
2 608 833 772	5 x 100 x 160 mm	5.20
2 608 833 773	5 x 150 x 210 mm	6.50
2 608 833 774	5.5 x 50 x 110 mm	4.70
2 608 833 775	5.5 x 100 x 160 mm	5.40
2 608 833 776	5.5 x 150 x 210 mm	6.80
2 608 833 777	6 x 50 x 110 mm	4.50
2 608 833 778	6 x 100 x 160 mm	5.30
2 608 833 779	6 x 150 x 210 mm	6.70
2 608 833 780	6 x 200 x 260 mm	7.80
2 608 833 781	6.5 x 50 x 110 mm	4.60
2 608 833 782	6.5 x 100 x 160 mm	5.30
2 608 833 783	6.5 x 150 x 210 mm	6.70
2 608 833 784	6.5 x 200 x 260 mm	7.80
2 608 833 785	7 x 50 x 110 mm	4.10
2 608 833 786	7 x 100 x 160 mm	5.60
2 608 833 787	7 x 150 x 210 mm	6.50
2 608 833 788	8 x 50 x 110 mm	4.70
2 608 833 789	8 x 100 x 160 mm	5.70
2 608 833 790	8 x 150 x 210 mm	6.50
2 608 833 791	8 x 200 x 260 mm	8.10
2 608 833 792	8 x 250 x 310 mm	9.60
2 608 833 793	8 x 300 x 360 mm	14.00
2 608 833 794	8 x 400 x 460 mm	16.20
2 608 833 795	9 x 100 x 160 mm	5.80
2 608 833 796	9 x 150 x 210 mm	6.40
2 608 833 797	10 x 50 x 110 mm	5.10
2 608 833 798	10 x 100 x 160 mm	5.80
2 608 833 799	10 x 150 x 210 mm	6.80
2 608 833 800	10 x 200 x 260 mm	8.60
2 608 833 801	10 x 250 x 310 mm	10.20
2 608 833 802	10 x 300 x 360 mm	14.90
2 608 833 803	10 x 400 x 460 mm	16.90
2 608 833 804	11 x 100 x 160 mm	6.00
2 608 833 805	11 x 150 x 210 mm	7.20
2 608 833 806	11 x 200 x 260 mm	9.10
2 608 833 807	12 x 100 x 160 mm	7.10
2 608 833 808	12 x 150 x 210 mm	8.50
2 608 833 809	12 x 200 x 260 mm	8.30
2 608 833 810	12 x 250 x 310 mm	11.20
2 608 833 811	12 x 300 x 360	13.50
2 608 833 812	12 x 400 x 460 mm	14.60

**BOSCH**

Invented for life

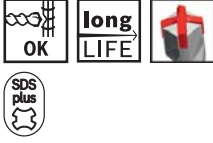
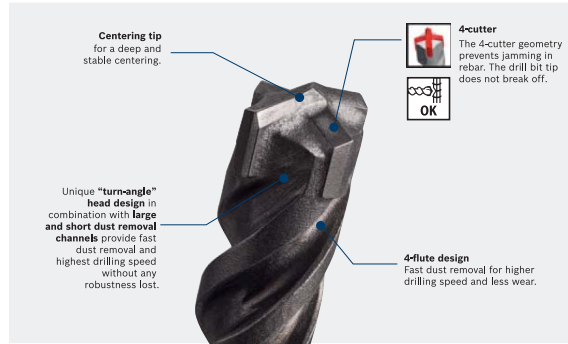
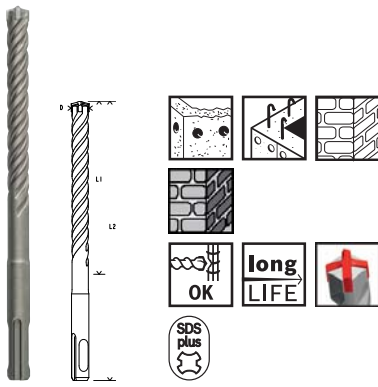

SDS Plus Drill Bit

Part Number	Description	List Price (SGD)
SDS Plus 5X		
2 608 833 813	13 x 100 x 160 mm	8.90
2 608 833 814	13 x 150 x 210 mm	9.10
2 608 833 815	13 x 200 x 260 mm	9.10
2 608 833 816	14 x 100 x 160 mm	9.00
2 608 833 817	14 x 150 x 210 mm	9.30
2 608 833 818	14 x 200 x 260 mm	12.30
2 608 833 819	14 x 250 x 310 mm	12.90
2 608 833 820	14 x 300 x 360 mm	15.60
2 608 833 821	14 x 400 x 460 mm	17.50
2 608 833 822	15 x 100 x 160 mm	11.40
2 608 833 823	15 x 200 x 260 mm	13.10
2 608 833 824	15 x 400 x 460 mm	18.60
2 608 833 825	16 x 150 x 210 mm	11.90
2 608 833 826	16 x 200 x 260 mm	13.80
2 608 833 827	16 x 250 x 310 mm	16.80
2 608 833 828	16 x 300 x 360 mm	18.30
2 608 833 829	16 x 400 x 460 mm	19.70
2 608 836 626	16 x 550 x 610 mm	18.20
2 608 836 627	16 x 950 x 1000 mm	23.70
2 608 836 628	17 x 150 x 210 mm	10.90
2 608 836 629	17 x 250 x 310 mm	12.60
2 608 836 631	18 x 150 x 200 mm	11.90
2 608 836 632	18 x 250 x 300 mm	16.20
2 608 836 633	18 x 400 x 450 mm	19.10
2 608 836 634	18 x 550 x 600 mm	22.00
2 608 836 636	19 x 150 x 200 mm	13.70
2 608 836 637	19 x 250 x 300 mm	17.30
2 608 836 638	19 x 400 x 450 mm	21.00
2 608 836 639	20 x 150 x 200 mm	15.00
2 608 836 640	20 x 250 x 300 mm	17.30
2 608 836 641	20 x 400 x 450 mm	21.00
2 608 836 642	20 x 550 x 600 mm	22.80
2 608 836 643	20 x 950 x 1000 mm	28.20
2 608 836 644	22 x 200 x 250 mm	16.50
2 608 836 645	22 x 400 x 450 mm	22.80
2 608 836 646	22 x 550 x 600 mm	23.70
2 608 836 647	24 x 200 x 250 mm	18.20
2 608 836 648	24 x 400 x 450 mm	23.70
2 608 836 649	25 x 200 x 250 mm	20.00
2 608 836 650	25 x 400 x 450 mm	25.50
2 608 836 651	26 x 200 x 250 mm	22.00
2 608 836 652	26 x 400 x 450 mm	28.20

**BOSCH**

Invented for life

**SDS Plus Chisel**

	Part Number	Description	List Price (SGD)
1	2 609 390 576	Pointed Chisel 250 mm Replacing 1 618 600 009	17.00
2	2 609 390 394	Flat Chisel 22 x 250 mm Replacing 1 618 600 010	17.00
3	2 608 690 101	Spade Chisel 40 x 250 mm - Replacing 1 618 601 002	26.30
4	1 618 601 004	Gouge Chisel 22 x 250 mm	21.50
5	2 608 690 007	Winged Gouging Chisel 22 x 250 mm	68.60
6	008	Tile Chisel, angled 40 x 250 mm (Refer 2 608 690 091)	16.70
7	010	Nail Driver Chisel 13 x 58 mm	23.70
8	006	Wood Chisel 20 x 175 mm	37.20
9	091	SDS Plus Tile Chisel 360 x 40 mm	26.00
	2 608 690 119	SDS Plus Pencil Chisel Pointed (160 mm)	4.70
	2 608 690 121	SDS Plus Pencil Chisel Flat (160 mm)	4.70
	2 608 690 120	SDS Plus Pencil Chisel Pointed (160 mm) 10 pieces per pack	33.00
	122	SDS Plus Pencil Chisel Flat (160 mm) 10 pieces per pack	33.00

SDS Plus Core Cutter

	2 608 550 057	SDS Plus Core Cutter Mounting Shank (M16 x 105 mm)	48.80
	2 608 598 110	SDS Plus Core Cutter Mounting Shank (M16 x 220 mm)	63.30
	046	SDS Plus Core Cutter Shank c/w Pilot Bit (67 x 175 mm)	71.80
	047	SDS Plus Core Cutter Shank c/w Pilot Bit (67 x 340 mm)	103.70
	048	SDS Plus Core Cutter Shank c/w Pilot Bit (67 x 440 mm)	111.00
	2 608 596 157	SDS Plus Core Cutter Pilot Drill Bit (8 x 120 mm)	14.70
	2 608 550 074	Core Cutter 40 x 60 mm - Replacing 2 608 550 062	94.30
	075	Core Cutter 50 x 60 mm - Replacing 2 608 550 063	99.90
	076	Core Cutter 68 x 60 mm - Replacing 2 608 550 064	121.10
	077	Core Cutter 82 x 60 mm - Replacing 2 608 550 065	119.70

SDS Max-2 Cutter Drill Bit

	2 608 578 003	SDS Max-2 12 x 340 mm	7.50
	2 608 578 760	SDS Max-2 13 x 340 mm	8.50
	2 608 578 761	SDS Max-2 13 x 540 mm	14.00
	2 608 578 005	SDS Max-2 14 x 340 mm	8.50
	2 608 578 007	SDS Max-2 16 x 340 mm	9.00
	2 608 578 762	SDS Max-2 16 x 540 mm	15.00
	2 608 578 010	SDS Max-2 18 x 340 mm	10.00
	013	SDS Max-2 18 x 540 mm	15.00
	014	SDS Max-2 20 x 340 mm	11.00
	017	SDS Max-2 20 x 540 mm	16.00
	018	SDS Max-2 22 x 340 mm	12.00
	021	SDS Max-2 22 x 540 mm	17.00
	022	SDS Max-2 25 x 340 mm	13.00
	025	SDS Max-2 25 x 540 mm	17.50
	026	SDS Max-2 28 x 340 mm	15.00
	029	SDS Max-2 28 x 540 mm	22.00
	030	SDS Max-2 30 x 340 mm	19.00
	032	SDS Max-2 30 x 540 mm	27.00
	033	SDS Max-2 32 x 340 mm	25.00
	035	SDS Max-2 32 x 540 mm	32.00
	037	SDS Max-2 35 x 540 mm	36.00
	2 608 578 763	SDS Max-2 38 x 340 mm	38.00
	2 608 578 764	SDS Max-2 38 x 540 mm	53.50
	2 608 578 039	SDS Max-2 40 x 540 mm	53.50

**BOSCH**

Invented for life

**Applicable to drilling in concrete and brick.**

Concrete



Brick

3

CYL-2 Concrete Drill Bit

CYL-2 Concrete Drill Bit

Part Number	Description	List Price (SGD)
2 608 578 114	Drill Bit CYL-2 3 x 30 x 60	0.75
115	Drill Bit CYL-2 4 x 40 x 75	0.80
116	Drill Bit CYL-2 5 x 50 x 85	0.90
117	Drill Bit CYL-2 5.5 x 50 x 85	1.00
118	Drill Bit CYL-2 6 x 60 x 100	1.00
119	Drill Bit CYL-2 6.5 x 60 x 100	1.10
120	Drill Bit CYL-2 8 x 80 x 120	1.40
159	Drill Bit CYL-2 9 x 80 x 120	1.65
121	Drill Bit CYL-2 10 x 80 x 120	2.00
122	Drill Bit CYL-2 12 x 90 x 150	3.00
123	Drill Bit CYL-2 14 x 90 x 150	4.00
160	Drill Bit CYL-2 16.0 x 90 x 150	4.60
124	Drill Bit CYL-2 Set (6 / 8 / 10)	4.60
155	Drill Bit CYL-2 Set (4 / 5 / 6 / 8 / 10)	6.30
156	Drill Bit CYL-2 Set (3 / 4 / 5 / 6 / 7 / 8 / 9 / 10)	7.00

**BOSCH**

Invented for life



SDS Max - 2 Cutter Drill Bit

Part Number	Description	List Price (SGD)
SDS Max - 2 Cutter Drill Bit		
2 608 578 003	12 x 340 mm	7.50
2 608 578 760	13 x 340 mm	8.50
2 608 578 761	13 x 540 mm	14.00
2 608 578 005	14 x 340 mm	8.50
2 608 578 007	16 x 340 mm	9.00
2 608 578 762	16 x 540 mm	15.00
2 608 578 010	18 x 340 mm	10.00
2 608 578 013	18 x 540 mm	15.00
2 608 578 014	20 x 340 mm	11.00
2 608 578 017	20 x 540 mm	16.00
2 608 578 018	22 x 340 mm	12.00
2 608 578 021	22 x 540 mm	17.00
2 608 578 022	25 x 340 mm	13.00
2 608 578 025	25 x 540 mm	17.50
2 608 578 026	28 x 340 mm	15.00
2 608 578 029	28 x 540 mm	22.00
2 608 578 030	30 x 340 mm	19.00
2 608 578 032	30 x 540 mm	27.00
2 608 578 033	32 x 340 mm	25.00
2 608 578 035	32 x 540 mm	32.00
2 608 578 037	35 x 540 mm	36.00
2 608 578 763	38 x 340 mm	38.00
2 608 578 764	38 x 540 mm	53.50
2 608 578 039	40 x 540 mm	53.50



2-flute spiral

- > Optimised 2-flute spiral for excellent dust transportation
- > Reduces heat development and increase the lifetime

Top grade carbide "Made by Bosch"

- > Highly durable top grade carbide tip
- > Proven cross cutter breaker design with 130° angle

Rebar Cutting Capability

- > 4-cutter head support drilling in reinforced concrete and minimise carbide cracks
- > Design of the carbide reduce jamming while drilling in concrete



SDS Max M4 Drill Bit

Part Number	Description	List Price (SGD)
SDS Max M4 Drill Bit (4 cutter design) / Max 4		
2 608 685 860	SDS-max M4 16x200/340	50.20
861	SDS-max M4 16x400/540	58.70
862	SDS-max M4 18x200/340	52.00
863	SDS-max M4 18x400/540	61.80
864	SDS-max M4 20x200/320	54.50
865	SDS-max M4 20x400/520	63.00
866	SDS-max M4 22x200/320	58.70
867	SDS-max M4 22x400/520	66.70
868	SDS-max M4 25x200/320	63.60
869	SDS-max M4 25x400/520	74.00
870	SDS-max M4 28x200/320	72.80
871	SDS-max M4 28x400/520	83.80
872	SDS-max M4 30x200/320	75.30
873	SDS-max M4 30x400/520	89.90
874	SDS-max M4 32x200/320	82.00
875	SDS-max M4 32x400/520	97.90
876	SDS-max M4 35x400/520	109.50
877	SDS-max M4 40x400/520	157.80

**BOSCH**

Invented for life



SDS-Max shank

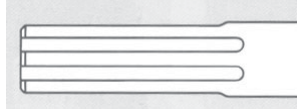

SDS Max Speed X Drill Bit

Part Number	Description	List Price (SGD)
SDS Max Speed X Drill Bit (High Performance) / Max 7		
2 608 586 738	SDS-max Speed X 12 x 200 / 340	51.70
739	SDS-max Speed X 12 x 400 / 540	67.40
740	SDS-max Speed X 12 x 600 / 740*	96.40
741	SDS-max Speed X 12 x 800 / 940*	134.60
744	SDS-max Speed X 14 x 200 / 340	53.80
745	SDS-max Speed X 14 x 400 / 540	69.30
746	SDS-max Speed X 14 x 600 / 740*	106.30
747	SDS-max Speed X 14 x 800 / 940*	136.30
749	SDS-max Speed X 15 x 200 / 340	64.00
750	SDS-max Speed X 15 x 400 / 540	80.30
751	SDS-max Speed X 16 x 200 / 340	71.70
752	SDS-max Speed X 16 x 400 / 540	83.90
753	SDS-max Speed X 16 x 600 / 740	110.10
754	SDS-max Speed X 16 x 800 / 940*	138.10
755	SDS-max Speed X 16 x 1200 / 1340*	253.40
756	SDS-max Speed X 17 x 200 / 340	74.30
757	SDS-max Speed X 17 x 400 / 540	88.30
758	SDS-max Speed X 18 x 200 / 340	74.30
759	SDS-max Speed X 18 x 400 / 540	88.30
760	SDS-max Speed X 18 x 600 / 740	113.60
761	SDS-max Speed X 18 x 800 / 940*	138.90
762	SDS-max Speed X 18 x 1200 / 1340*	261.30
763	SDS-max Speed X 19 x 200 / 320	77.80
764	SDS-max Speed X 19 x 400 / 520	90.00
765	SDS-max Speed X 20 x 200 / 320	77.80
766	SDS-max Speed X 20 x 400 / 520	90.00
767	SDS-max Speed X 20 x 600 / 720	115.40
768	SDS-max Speed X 20 x 800 / 920*	141.60
769	SDS-max Speed X 20 x 1200 / 1320*	269.20
770	SDS-max Speed X 22 x 200 / 320	83.90
771	SDS-max Speed X 22 x 400 / 520	95.30
772	SDS-max Speed X 22 x 600 / 720	119.70
773	SDS-max Speed X 22 x 800 / 920*	143.30
774	SDS-max Speed X 22 x 1200 / 1320*	296.30

*On Indent Basis.

Prices are subject to change without prior notice.

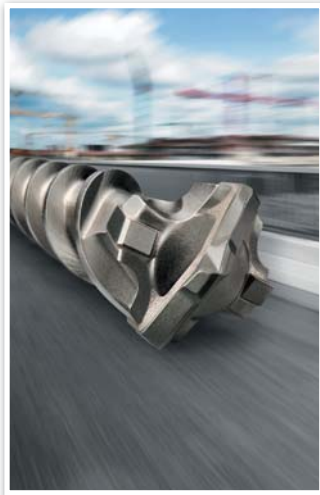
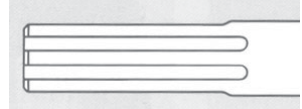
SDS-Max shank

SDS Max Speed X Drill Bit

Part Number	Description	List Price (SGD)
SDS Max Speed X Drill Bit (High Performance) / Max 7		
2 608 586 775	SDS-max Speed X 24 x 200 / 320	90.90
776	SDS-max Speed X 24 x 400 / 520	105.70
777	SDS-max Speed X 25 x 200 / 320	90.90
778	SDS-max Speed X 25 x 400 / 520	105.70
779	SDS-max Speed X 25 x 600 / 720	138.10
780	SDS-max Speed X 25 x 800 / 920*	171.30
781	SDS-max Speed X 25 x 1200 / 1320*	318.10
782	SDS-max Speed X 26 x 200 / 320	104.00
783	SDS-max Speed X 26 x 400 / 520	119.70
784	SDS-max Speed X 28 x 200 / 320	104.00
785	SDS-max Speed X 28 x 400 / 520	119.70
786	SDS-max Speed X 28 x 600 / 720	154.70
787	SDS-max Speed X 28 x 800 / 920*	190.50
788	SDS-max Speed X 28 x 1200 / 1320*	333.80
789	SDS-max Speed X 30 x 200 / 320	107.50
790	SDS-max Speed X 30 x 400 / 520	128.50
791	SDS-max Speed X 32 x 200 / 320	117.10
792	SDS-max Speed X 32 x 400 / 520	139.80
793	SDS-max Speed X 32 x 600 / 720	175.70
794	SDS-max Speed X 32 x 800 / 920*	209.70
795	SDS-max Speed X 32 x 1200 / 1320*	351.30
796	SDS-max Speed X 35 x 400 / 520	156.50
797	SDS-max Speed X 35 x 600 / 720	221.10
798	SDS-max Speed X 35 x 800 / 920*	297.10
799	SDS-max Speed X 35 x 1200 / 1320*	395.00
800	SDS-max Speed X 38 x 400 / 520	186.20
801	SDS-max Speed X 38 x 600 / 720	220.20
802	SDS-max Speed X 40 x 400 / 520	225.50
803	SDS-max Speed X 40 x 600 / 720	269.20
804	SDS-max Speed X 40 x 800 / 920*	304.10
805	SDS-max Speed X 40 x 1200 / 1320*	437.80
806	SDS-max Speed X 45 x 400 / 520	275.30
807	SDS-max Speed X 52 x 400 / 520	360.10

*On Indent Basis.

**BOSCH**

Invented for life

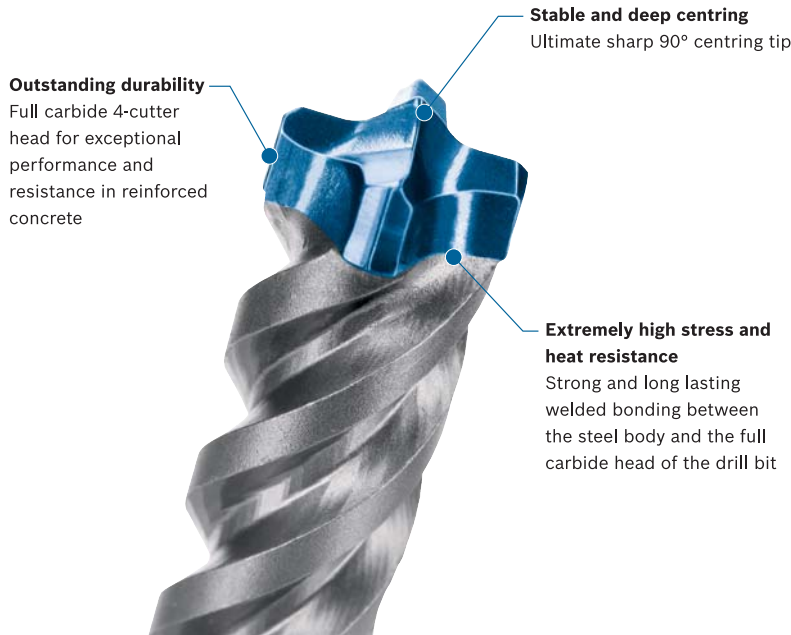

SDS Max 8X Drill Bit

Part Number	Description	List Price (SGD)
SDS Max 8X Drill Bit		
2 608 578 602	SDS-MAX 8 X 12 x 200 x 340 MM	67.00
2 608 578 603	SDS-MAX 8 X 12 x 400 x 540 MM	77.00
2 608 578 604	SDS-MAX 8 X 12 x 600 x 740 MM*	92.00
2 608 578 605	SDS-MAX 8 X 12 x 800 x 940 MM*	108.00
2 608 578 606	SDS-MAX 8 X 14 x 200 x 340 MM	67.00
2 608 578 607	SDS-MAX 8 X 14 x 400 x 540 MM	78.00
2 608 578 608	SDS-MAX 8 X 14 x 600 x 740 MM*	95.00
2 608 578 609	SDS-MAX 8 X 14 x 800 x 940 MM*	112.00
2 608 578 612	SDS-MAX 8 X 16 x 200 x 340 MM	75.00
2 608 578 613	SDS-MAX 8 X 16 x 400 x 540 MM	83.00
2 608 578 614	SDS-MAX 8 X 16 x 600 x 740 MM*	100.00
2 608 578 615	SDS-MAX 8 X 16 x 800 x 940 MM*	150.00
2 608 578 619	SDS-MAX 8 X 18 x 200 x 340 MM	83.00
2 608 578 620	SDS-MAX 8 X 18 x 400 x 540 MM	92.00
2 608 578 621	SDS-MAX 8 X 18 x 600 x 740 MM*	100.00
2 608 578 622	SDS-MAX 8 X 18 x 800 x 940 MM*	108.00
2 608 578 626	SDS-MAX 8 X 20 x 200 x 320 MM	83.00
2 608 578 627	SDS-MAX 8 X 20 x 400 x 520 MM	92.00
2 608 578 628	SDS-MAX 8 X 20 x 600 x 720 MM*	108.00
2 608 578 629	SDS-MAX 8 X 20 x 800 x 920 MM*	158.00
2 608 578 631	SDS-MAX 8 X 22 x 200 x 320 MM	77.00
2 608 578 632	SDS-MAX 8 X 22 x 400 x 520 MM	83.00
2 608 578 633	SDS-MAX 8 X 22 x 600 x 720 MM*	108.00
2 608 578 634	SDS-MAX 8 X 22 x 800 x 920 MM*	167.00
2 608 578 636	SDS-MAX 8 X 24 x 200 x 320 MM	83.00
2 608 578 637	SDS-MAX 8 X 24 x 400 x 520 MM	92.00
2 608 578 638	SDS-MAX 8 X 25 x 200 x 320 MM	92.00
2 608 578 639	SDS-MAX 8 X 25 x 400 x 520 MM	100.00
2 608 578 640	SDS-MAX 8 X 25 x 600 x 720 MM*	117.00
2 608 578 641	SDS-MAX 8 X 25 x 800 x 920 MM*	183.00
2 608 578 643	SDS-MAX 8 X 26 x 200 x 320 MM	100.00
2 608 578 644	SDS-MAX 8 X 26 x 400 x 520 MM	108.00
2 608 578 645	SDS-MAX 8 X 28 x 200 x 320 MM	108.00
2 608 578 646	SDS-MAX 8 X 28 x 400 x 520 MM	117.00
2 608 578 647	SDS-MAX 8 X 28 x 600 x 720 MM*	133.00
2 608 578 648	SDS-MAX 8 X 28 x 800 x 920 MM*	183.00
2 608 578 650	SDS-MAX 8 X 30 x 200 x 320 MM	117.00
2 608 578 651	SDS-MAX 8 X 30 x 400 x 520 MM	125.00
2 608 578 652	SDS-MAX 8 X 32 x 200 x 320 MM	125.00
2 608 578 653	SDS-MAX 8 X 32 x 400 x 520 MM	133.00
2 608 578 654	SDS-MAX 8 X 32 x 600 x 720 MM*	150.00
2 608 578 655	SDS-MAX 8 X 32 x 800 x 920 MM*	217.00

*On Indent Basis.

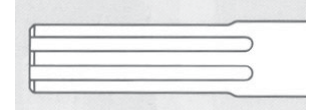
SDS-Max shank

SDS Max Breakthrough Drill Bit

	Part Number	Description	List Price (SGD)
1	1 618 596 455	45 x 590 / 450 mm	434.00
	456	45 x 990 / 850 mm	471.00
	457	55 x 590 / 450 mm	488.00
	458	55 x 990 / 850 mm	525.00
	459	65 x 590 / 450 mm	575.00
	460	65 x 990 / 850 mm	609.00
	461	80 x 590 / 450 mm	752.00
	462	80 x 990 / 850 mm	796.00
	029	Pilot Drill Bit	41.50

SDS Max Core Cutter

2	F 00Y 145 188	45 x 290 / 160 mm	320.00
	189	45 x 550 / 420 mm	325.00
	190	50 x 290 / 160 mm	356.00
	191	50 x 550 / 420 mm	403.00
	192	55 x 290 / 160 mm	317.00
	193	55 x 550 / 420 mm	338.00
	194	68 x 290 / 160 mm	324.00
	195	68 x 550 / 420 mm	354.00
	196	82 x 290 / 160 mm	354.00
	197	82 x 550 / 420 mm	432.00
	198	90 x 290 / 160 mm	428.00
	199	90 x 550 / 420 mm	474.00
	200	100 x 430 / 310 mm	445.00
	201	125 x 430 / 310 mm	599.00
	202	150 x 430 / 310 mm	934.00
	203	Pilot Drill Bit 11.5 x 136 / 84 mm	20.40
	204	Fixing Pin	2.50

**BOSCH**

Invented for life

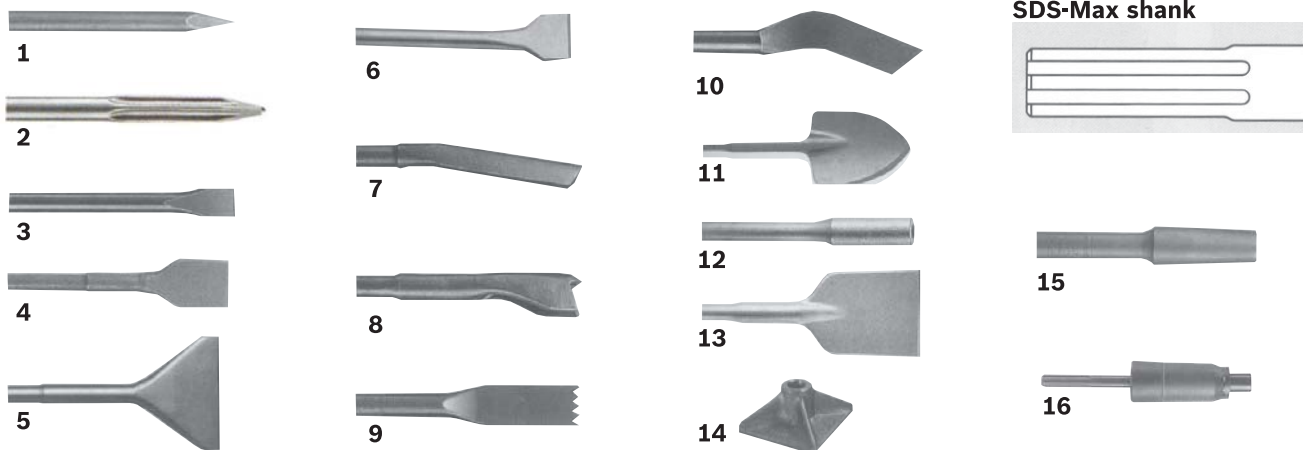
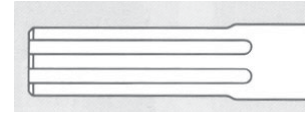
**SDS-Max shank****SDS Max Chisel**

Part Number	Description	List Price (SGD)
1	1 618 600 023 Pointed Chisel 280 mm	25.30
	012 Pointed Chisel 600 mm	33.20
	2 608 690 167 SDS Max R-Tec Speed Chisel (1 pc) - Pointed	29.50
	2 608 690 124 SDS Max R-Tec Sharp Chisel (1 pc) - Flat	29.50
2	2 608 690 168 SDS Max R-Tec Speed Chisel (10 pcs) - Pointed	260.00
	2 608 690 166 SDS Max R-Tec Sharp Chisel (10 pcs) - Flat	260.00
	2 608 690 128 SDS Max Pointed Chisel (10 pcs)	146.00
	2 608 690 125 SDS Max Flat Chisel (10 pcs)	146.00
	2 608 690 231 SDS Max 400 mm Pointed Chisel (Eco range) (10 pcs)	120.00
	2 608 690 232 SDS Max 600 mm Pointed Chisel (Eco range) (10 pcs)	180.00
	2 608 690 233 SDS Max 400 mm Flat Chisel (Eco range) (10 pcs)	120.00
	2 608 690 234 SDS Max 600 mm Flat Chisel (Eco range) (10 pcs)	180.00
3	1 618 600 210 Flat Chisel 25 x 280 mm	28.80
	1 618 600 203 Flat Chisel 25 x 600 mm	38.60
4	2 608 690 097 Spade Chisel 50 x 400 mm	44.30
	1 618 601 008 Spade Chisel 80 x 300 mm	56.20
5	007 Wide Spade Chisel 115 x 350 mm	66.20
6	2 608 690 098 Tile Chisel 50 x 300 mm	35.40
	1 618 601 019 Tile Chisel 80 x 300 mm	45.90
7	101 Gouging Chisel 26 x 300 mm	38.40
8	102 Chasing Chisel 32 x 300 mm	56.20
9	302 Toothed Chisel 32 x 300 mm	76.20
10	303 Mortar Raking Chisel 10 x 300 mm	59.40
11	017 Excavation Chisel 110 x 400 mm	101.00
12	2 608 690 004 Earth Driving Rod 13 x 260 mm	93.70
	005 Earth Driving Rod 16.5 x 260 mm	82.60
13	003 Asphalt Chisel 400 mm	98.40
	1 618 633 101 Tamping Plate 120 x 120 mm	232.00
14	1 618 633 102 Tamping Plate 150 x 150 mm	271.00
15	1 618 609 003 Shank for Tamping Plate and Bush Hammer Head 220 mm	48.70

SDS Max Adapter

16	1 618 598 159 SDS Max to SDS Plus Adapter	70.90
	2 608 598 019 SDS Max o 3/4" Drive	54.30

**BOSCH**

Invented for life

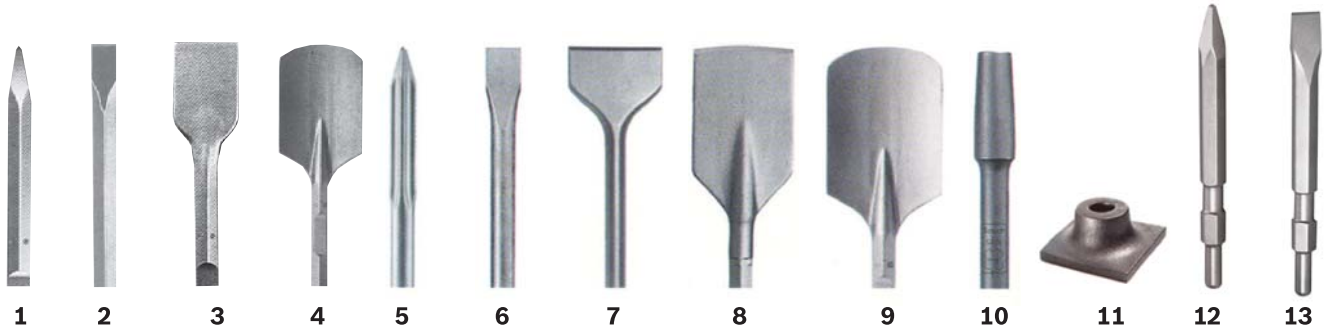
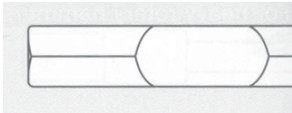
1 1/8" Hexagonal shank for USH 27**Chisel**

	Part Number	Description	List Price (SGD)
For Model USH 27 & GSH 27			
1	2 608 690 106	Pointed Chisel, 400 mm (Star Point)	44.70
	1 618 660 000	Pointed Chisel, 400 mm	54.30
	1 618 600 019	Pointed Chisel, 520 mm	66.00
	2 608 690 108	Flat Chisel 28 x 36 x 400 mm	49.50
2	2 608 690 206	Flat Chisel, 28 x 520 mm	174.00
3	1 618 661 000	Spade Chisel, 80 x 400 mm	232.00
4	1 618 662 000	Digger Steel Chisel, 135 x 400 mm	145.00
	1 618 609 006	Toolholder for Tamping Plate GSH 27	154.00
For Model GSH 16-30			
5	2 608 690 111	30mm Hexagonal Star Point 400 mm	51.00
6	112	30mm Hexagonal Flat Chisel 400 mm	60.00
7	113	30mm Hexagonal Spade Chisel, 75 x 450 mm	118.00
8	114	30mm Hexagonal Asphalt Cutter, 125 x 450 mm	280.00
9	110	30mm Hexagonal Spade Chisel, 135 x 450 mm	210.00
10	115	Toolholder 400 mm	177.00
11	1 618 633 104	Tamping Plate 150 x 150 mm for GSH 16	435.00
	105	Tamping Plate 200 x 200 mm for GSH 16	531.00
Hex 17mm Chisel			
12	2 608 690 350	Hex. Pointed Chisel (17 x 280 mm) - 10 pcs	39.00
13	2 608 690 351	Hex. Flat Chisel (17 x 280 mm) - 10 pcs	39.00

**BOSCH**

Invented for life



3

Others

Rotary Hammer Accessories

Part Number	Description	List Price (SGD)
1 618 571 014	SDS Plus Adapter with Chuck (2.5mm - 13mm)	126.00
1 617 000 132	SDS Plus Adapter	10.60
2 608 598 037	SDS Plus Adapter to 1/2" Drive	25.90
2 608 572 059	SDS Plus Quick Change Chuck (For Model GBH 4 DSC / DFE)	61.80
2 608 572 112	SDS Plus Quick Change Chuck (For Model GBH 2-24 DFR)	60.52
2 608 572 213	SDS Plus Quick Change Chuck (For Model GBH 2-26 DFR)	67.60
1 617 000 332	Keyless Chuck with Adapter (For Model GBH 2-24 DFR)	153.50
2 608 572 212	Keyless Chuck with Adapter (For Model GBH 2-26 DFR)	101.40
2 605 411 044	Dust Bag (For Model GAH 500 DSR)	49.30
2 607 002 610	Suction Tube (For Model GBH 2-23 REA)	9.70
2 607 002 611	Adapter Set (For Model GBH 2-23 REA)	31.90
Auxiliary Handle		
1 612 025 078	Auxiliary Handle for GBH 36 V-LI Compact	25.00
2 602 025 062	Auxiliary Handle for GBH 38	38.30
063	Auxiliary Handle for GSH 4 / 5CE	67.60
076	Auxiliary Handle for GSH 10C / 11E	41.60
2 602 025 103	Auxiliary Handle for GBH 7-46	51.60
1 612 025 032	Auxiliary Handle for GBH 2SE, GBH 2-24	19.70
2 602 025 112	Auxiliary Handle for GBH 3-28 E	14.80
077	Auxiliary Handle for GBH 4DSC / DFE	29.60
2 602 025 117	Handle - GBH 5-38, GSH 388	18.50
Chuck		
2 2 608 572 075	10 mm Chuck 1/4" Shank (GDR)	53.50
1 608 571 048	1/2" Chuck 1/2" - 20 UNF	37.30
053	3/8" Chuck 3/8" - 24 UNF	26.80
054	3/8" Chuck 1/2" - 20 UNF	26.80
056	5/8" Chuck 5/8" - 16 UNF	67.60
3 062	Key Chuck 1/2" - 20 UNF 13 mm (W/hole)	15.20
1 618 571 068	3/8" Key Chuck 1/2" - 20 UNF, "Reversible"	17.00
2 608 571 078	10 mm, 3/8" - 24 UNF (W/O) hole	8.00
1 603 115 004	Morse Taper 16 mm x 5/8" - 16 UNF (GBM 23-2)	28.90
2 608 572 217	10 mm Keyless Chuck - 24 UNF	10.00
2 608 572 253	13 mm Chuck with Hole (1.5 - 13 mm), 1/2" - 20 UNF, "Reversible"	9.70
4 257	Chuck for GSR 10.8 V-LI-2	16.30
2 609 256 969	Angle Screw Adaptor for IXO III	18.70
2 609 256 968	Torque Adaptor IXO III	20.80
2 608 571 020	16 mm Chuck B16 for GBM 16-2RE	85.00



Cordless Multi-Cutter Accessories

Part Number Description List Price (SGD)



2 608 662 223 OMT Hard Wood & Metal Set (3pcs) 62.90



2 608 662 342 OMT Basic Tile Set (3pcs) 36.00



2 608 662 343 OMT Basic Wood Set (3pcs) 36.00

Part Number Description Width Length Usage / Application List Price (SGD)



2 608 661 644 AIZ 32 APB 32 mm 50 mm ▶ Deep plunge cutting in wood, abrasive wooden materials, plastics
BIM plunge-cutting saw blade Wood and Metal ▶ Cutting non-ferrous pipes and profiles with smaller dimensions
▶ Cutting non-hardened nails, screws and steel profiles with smaller dimensions **16.50**



645 AIZ 32 BSPB 32 mm 50 mm ▶ Plunge cutting in a laminated board or hardwood (e.g. for installing a ventilation grille) **17.40**
BIM plunge-cutting saw blade ▶ Cutting a recess in furniture elements (e.g. to enable access to a mains socket)
Hardwood ▶ Flush cutting wooden components (e.g. dowels, tenons made of hardwood) to length



637 AIZ 32 EPC 32 mm 50 mm ▶ Plunge cutting in softwood (e.g. for installing a ventilation grille) **16.90**
HCS plunge-cutting saw blade ▶ Cutting a recess in furniture elements (e.g. to enable access to a mains socket)
Wood ▶ Flush cutting wooden components (e.g. dowels, tenons) to length



638 AIZ 20 EC 20 mm 30 mm ▶ Plunge cutting in softwood (e.g. for installing a ventilation grille) **18.20**
HCS plunge-cutting saw blade ▶ Cutting a recess in furniture elements (e.g. to enable access to a mains socket)
Wood ▶ Flush cutting wooden components (e.g. dowels, tenons) to length



639 AIZ 10 EC 10 mm 30 mm ▶ Plunge cutting in softwood (e.g. for installing a ventilation grille) **16.10**
HCS plunge-cutting saw blade ▶ Cutting a recess in furniture elements (e.g. to enable access to a mains socket)
Wood ▶ Filigree adjustment work in wood (e.g. subsequently sawing recesses for locks and fittings)



640 AIZ 20 AB 20 mm 30 mm ▶ Flush cutting a nail **16.80**
BIM plunge-cutting saw blade ▶ Flush cutting a copper pipe
Metal ▶ Plunge cutting in plasterboard



641 AIZ 10 AB 10 mm 20 mm ▶ Flush cutting a nail **18.20**
BIM plunge-cutting saw blade ▶ Filigree adjustment work on non-ferrous profiles
Metal ▶ Plunge cutting in plasterboard



646 ATZ 52 SC 52 mm 26 mm ▶ Removing mortar or tile adhesive (e.g. when replacing damaged tiles) **15.10**
HCS scraper, rigid ▶ Removing mortar and concrete residues
▶ Removing hard, brittle carpet adhesive residues









647 ATZ 52 SFC 52 mm 38 mm ▶ Removing soft carpet adhesive residues **15.10**
HCS scraper, flexible ▶ Removing paint residues
▶ Removing silicone joints

2 608 190 054 Dust Extract Adaptor (Gop) 30.00



Cordless Multi-Cutter Accessories

	Part Number	Description	Diameter	Usage / Application	List Price (SGD)	
	2 608 661 636	ACZ 85 EB BIM segment saw blade Wood and Metal	85 mm	<ul style="list-style-type: none"> Cutting door frames to length on the floor (e.g. softwood, hardwood, veneered boards, laminated boards) Cutting out laminate/parquet (e.g. for installing a partition wall) Cutting smaller profile strips to length (e.g. aluminium floor cover strip) 	29.90	
	643	ACZ 85 EC HCS segment saw blade Wood	85 mm	<ul style="list-style-type: none"> Plunge cutting in solid wood (e.g. for installing a ventilation grille) Flush cutting wood (e.g. a protruding tenon on a wood joint) Cutting a plastic pipe (PVC) to length 	30.20	
	642	ACZ 85 RT3 HM-RIFF segment saw blade	85 mm	<ul style="list-style-type: none"> Routing joints on wall and floor tiles Smaller cutouts in soft wall tiles Routing grooves in porous concrete, for laying concealed cables and pipes 	42.10	
	648	AVZ 78 RT HM-RIFF sanding plate	78 mm	<ul style="list-style-type: none"> Removing mortar or tile adhesive (e.g. when replacing damaged tiles) Removing carpet adhesive residues from a mineral surface Rasping wood, for coarse adjustment work 	53.90	
	2 608 000 493	AVI 93 G Sanding plate	93 mm	<ul style="list-style-type: none"> Sanding plate with micro Velcro-type fastening system Quick, easy sanding sheet changes 	33.70	
	2 608 607 540	Sanding sheet set Red Wood-top 10 pcs / pack	93 mm	60; 80; 100; 120; 180	<ul style="list-style-type: none"> For pre-sanding (e.g. of rough, uneven beams and boards) For surface sanding and sanding down of surface blemishes For finishing and fine sanding of wood 	8.40
	541	Sanding sheet set Red Wood 10 pcs / pack	93 mm	60; 80; 100; 120; 180	<ul style="list-style-type: none"> For pre-sanding (e.g. of rough, uneven beams and boards) For surface sanding and sanding down of surface blemishes For finishing and fine sanding of wood 	13.20
	542	Sanding sheet set White Paint 10 pcs / pack	93 mm	60; 80; 100; 240; 320	<ul style="list-style-type: none"> For sanding down paint For sanding precoat paint For finishing of primers prior to painting 	12.10
	543	Sanding sheet set Black Stone 10 pcs / pack	93 mm	120; 240; 400; 600; 1200	<ul style="list-style-type: none"> For shaping and edge chamfering For fine sanding when shaping For gloss sanding and rounding off edges 	12.10
Existing delta sanding sheet range (Bosch 93 mm, 6 holes) suitable for GOP 10.8 V-Li Professional						

	Part Number	Description	Width	Length	Usage / Application	(5 pcs / Pack)	List Price (SGD)
	2 608 661 629	AIZ 32 APB BIM plunge-cutting saw blade Wood and Metal 5 pcs / pack	32 mm	50 mm	<ul style="list-style-type: none"> Deep plunge cutting in wood, abrasive wooden materials, plastics Cutting non-ferrous pipes and profiles with smaller dimensions Cutting non-hardened nails, screws and steel profiles with smaller dimensions 		62.00
	630	AIZ 32 BSPB BIM plunge-cutting saw blade Hard Wood 5 pcs / pack	32 mm	50 mm	<ul style="list-style-type: none"> Plunge cutting in a laminated board or hardwood (e.g. for installing a ventilation grille) Cutting a recess in furniture elements (e.g. to enable access to a mains socket) Flush cutting wooden components (e.g. dowels, tenons made of hardwood) to length 		65.00
	626	AIZ 32 EC HCS plunge-cutting saw blade Wood 5 pcs / pack	32 mm	40 mm	<ul style="list-style-type: none"> Plunge cutting in softwood (e.g. for installing a ventilation grille) Cutting a recess in furniture elements (e.g. to enable access to a mains socket) Flush cutting wooden components (e.g. dowels, tenons) to length 		63.10
	627	AIZ 20 EC HCS plunge-cutting saw blade Wood 5 pcs / pack	20 mm	30 mm	<ul style="list-style-type: none"> Plunge cutting in softwood (e.g. for installing a ventilation grille) Cutting a recess in furniture elements (e.g. to enable access to a mains socket) Flush cutting wooden components (e.g. dowels, tenons) to length 		60.90
	628	AIZ 20 AB BIM plunge-cutting saw blade Metal 5 pcs / pack	20 mm	20 mm	<ul style="list-style-type: none"> Flush cutting a nail Flush cutting a copper pipe Plunge cutting in plasterboard 		62.90



Spare Parts Price List

1st Jul 2017 - 31 Dec 2018

Tool Model	Part No.	Description	Price
IXO	2 607 225 419	Charger	\$19.50
GSB 120-LI	2 609 199 258	Motor	\$25.00
	2 609 125 169	Electronics Module	\$25.00
	1 600 A00 DM7	Gear Box	\$43.00
	2 609 111 312	Keyless Chuck	\$15.00
GSR 120-LI	2 609 199 258	Motor	\$25.00
	2 609 125 169	Electronics Module	\$25.00
	1 600 A00 F8P	Gear Box	\$35.00
	2 609 111 312	Keyless Chuck	\$15.00
GKS 12 V-LI	1 619 P11 537	Sunction Nozzle	\$12.00
	1 619 P11 536	Parallel-Guide	\$9.00
GOP 12 V-LI	2 609 110 797	Screw	\$3.00
	2 609 199 180	DC Motor	\$51.00
GST 12 V-LI	1 619 P10 585	Sunction Nozzle	\$6.00
	1 619 P10 586	DC Motor	\$41.00
GAS 12 V-LI	1 600 A00 2PS	Filter	\$9.20
	1 600 A00 2PP	Crevice Nozzle	\$3.80
GDR 120-LI	1 600 A00 PE3	Motor	\$14.00
GDR 12-LI	2 609 199 281	DC Motor	\$25.00
	1 607 233 5DD	Electronics Module	\$35.00
GDR 12 V-EC	1 607 233 581	Electronic Module	\$106.00
	2 609 199 661	Brushless DC Motor	\$65.00
GSA 12 V-LI	1 619 P08 652	DC Motor	\$50.00
	1 619 P08 618	Electronics Module	\$90.50
GSR 12-2-LI	2 609 199 258	DC Motor	\$25.00
	1 607 233 485	Electronics Module	\$43.00
	2 609 199 786	Gear Box	\$22.00
	2 609 111 312	Keyless Chuck	\$15.00
GSR 12 V-EC	1 607 233 568	Electronics Module	\$107.00
	2 609 199 654	Brushless DC Motor	\$53.00
	2 609 111 562	Gear Box	\$41.00
GDR 14.4 V-LI	2 609 199 169	Carbon Brush	\$9.50
	2 609 199 313	DC Motor	\$94.50
GDR 1440-LI	2 609 199 615	Electronics Module	\$33.00
	2 609 199 419	Motor	\$30.00
GSR 1800-LI	2 609 120 395	DC Motor	\$30.00
	2 609 199 337	Gear Box	\$35.00
	2 609 199 616	Electronics Module	\$33.00
	1 619 X00 824	Keyless Chuck	\$8.50
GSR 180-LI	1 607 000 CZ1	Carbon Brush	\$2.00
	1 607 022 66N	DC Motor	\$38.00
GDS 18 V-LI	2 609 199 169	Carbon Brush	\$9.50
	2 609 199 313	DC Motor	\$94.50
	1 607 233 480	Electronics Module	\$83.00

Tool Model	Part No.	Description	Price
GDS 18 V-EC	2 609 199 548	DC Motor	\$85.00
	1 607 233 470	Electronics Module	\$106.00
GDS 18 V-LI HT	2 610 943 875	Motor	\$223.00
	2 610 943 880	Coupling Half	\$27.00
	2 610 011 263	Electronic Assembly	\$181.00
GDX 18 V-LI	2 609 199 169	Carbon Brush	\$9.50
	2 609 199 508	DC Motor	\$94.50
	1 607 233 480	Electronics Module	\$83.00
GDX 18 V-EC	2 609 199 548	DC Motor	\$85.00
	1 607 233 470	Electronics Module	\$106.00
GOP 18 V-EC	2 609 199 490	Electronics Module	\$85.00
	2 609 199 680	Armature Assembly	\$57.00
GSB 180-LI	1 607 000 CZ1	Carbon Brush	\$2.00
	1 607 022 66N	DC Motor	\$38.00
GSB 18-2-LI	2 609 199 626	Motor	\$50.00
	1 607 233 544	Electronics Module	\$107.00
	2 609 111 312	Keyless Chuck	\$15.00
GSB 18 V-EC	1 619 P08 583	Stator	\$54.00
	2 609 199 671	Rotor	\$49.00
GSR 18 V-EC	1 619 P08 583	Stator	\$54.00
	2 609 199 671	Rotor	\$49.00
GSS 18 V-LI	2 609 101 073	Plate	\$8.00
	2 609 170 230	Felt	\$3.20
	2 609 111 892	Spring	\$2.00
GST 18 V-LI	2 600 780 173	Lifting Rod	\$45.00
	2 601 016 906	Base Plate	\$32.50
	2 601 321 077	Roller Lever	\$12.50
GWS 18 V-LI	1 617 000 6B0	Elektromotor	\$106.00
	1 607 233 340	Electronics Module	\$83.00
	2 607 202 071	On-off switch	\$17.00
GGs 18 V-LI	1 617 000 6B0	Elektromotor	\$106.00
	1 607 233 340	Electronics Module	\$83.00
GAS 18 V-1	1 619 PB2 034	Filter	\$7.00
GHO 18 V-LI	2 604 736 001	Toothed Belt	\$8.50
	2 606 625 910	Drive Unit	\$115.00
GBH 18 V-120	1 619 PA 9087	Nozzle	\$5.80
GBH 18 V-EC	1 617 000 6D3	Protection Sleeve	\$12.00
	1 607 233 376	Electronics Module	\$135.50
	1 618 700 083	Hammer Piston	\$12.90
	1 610 210 244	O-ring	\$2.00
	1 607 000 CC8	Jack Shaft	\$64.00
GBH 180-LI	1 600 A00 F9H	Electronic Module	\$64.00
	1 619 P14 347	Jack Shaft	\$32.00
	1 619 P14 346	Armature	\$32.00
	1 610 210 244	O-ring	\$2.00
	1 618 700 083	Hammer Piston	\$12.90
GBH 36 V-EC	1 610 210 244	O-ring	\$2.00
	1 618 700 083	Hammer Piston	\$12.90
	1 617 000 668	Jack Shaft	\$64.00
	1 617 000 6D3	Protection Sleeve	\$12.00
	1 607 233 316	Electronic Module	\$115.00
	1 611 015 060	Sealing Frame	\$6.50

Tool Model	Part No.	Description	Price
GSA 36 V-LI	2 610 920 684	Blade Holder	\$47.00
	2 610 935 005	Supporting Foot	\$8.50
GBH 36 V-LI PLUS	1 607 022 662	DC Motor	\$135.00
	1 600 A01 1GZ	Electronic Module	\$135.00
	1 617 000 6CB	Tool Holding Fixture	\$12.50
GBM 10 RE	2 610 391 290	Carbon Brush	\$6.50
	2 607 200 623	Switch	\$17.50
	2 608 571 078	Chuck With Key (10mm)	\$8.00
GBM 13 RE	2 610 391 290	Carbon Brush	\$6.50
	2 607 200 623	Switch	\$17.50
	2 608 572 253	Chuck With Key	\$9.70
GBM 13 HRE	1 607 031 222	Carbon Brush	\$5.50
	2 607 200 920	On-off Switch	\$35.50
	2 608 572 253	Chuck With Key	\$9.70
GBM 16-2 RE	3 607 014 012	Carbon Brush	\$24.00
	1 607 200 075	Switch	\$99.50
GBM 23-2 E	3 607 014 012	Carbon Brush	\$24.00
	1 607 200 075	Switch	\$99.50
GBM 350	1 619 P20 086	Carbon Brush	\$2.00
	2 607 200 623	Switch	\$17.50
	2 608 571 078	Chuck With Key (10mm)	\$8.00
GSB 10 RE	2 610 391 290	Carbon Brush	\$6.50
	2 607 200 623	Switch	\$17.50
	2 608 571 078	Chuck With Key (10mm)	\$8.00
GSB 13 RE	2 610 391 290	Carbon Brush	\$6.50
	2 607 200 623	Switch	\$17.50
	2 608 572 253	Chuck With Key (10mm)	\$8.00
GSB 16 RE	2 610 391 290	Carbon Brush	\$6.50
	1 607 200 270	On-off Switch	\$32.00
	2 608 572 253	Chuck With Key (10mm)	\$8.00
GSB 20-2 RE	1 617 000 525	Carbon Brush	\$8.00
	1 607 200 270	On-off Switch	\$32.00
	2 608 572 253	Chuck With Key (10mm)	\$8.00
GSB 21-2 RCT	1 617 200 525	Carbon Brush	\$8.00
	2 607 200 679	Switch	\$41.00
GBH 2-20 RE	1 607 031 222	Carbon Brush	\$5.50
	1 617 200 542	On-off Switch	\$25.00
	1 619 P09 818	Armature	\$60.00
	1 619 P08 313	Field Coil	\$21.00
GBH 2-23 RE	1 617 000 525	Carbon Brush	\$8.00
	1 617 200 532	On-off Switch	\$25.00
	1 617 000 524	Armature	\$70.00
	2 604 220 693	Coil	\$25.00
GBH 2-23 REA	1 618 190 014	Dust Extractor	\$78.00
	1 617 000 525	Carbon Brush	\$8.00
	1 617 200 532	On-off Switch	\$25.00
	1 619 P04 479	Filter	\$22.50
GBH 2-23 DRE	1 617 000 525	Carbon Brush	\$8.00
	1 617 200 532	On-off Switch	\$25.00
GBH 2-24 RE / DRE	1 617 000 525	Carbon Brush	\$8.00
	1 607 200 32D	Switch	\$20.00
	1 619 P13 626	Armature	\$33.00

Tool Model	Part No.	Description	Price
GBH 2-26 RE	1 617 000 525	Carbon Brush	\$8.00
	1 617 200 532	On-off Switch	\$25.00
	1 619 P10 005	Armature	\$43.00
	1 614 220 127	Coil	\$19.00
GBH 2-26 DFR	1 617 000 525	Carbon Brush	\$8.00
	1 617 200 532	On-off Switch	\$25.00
	1 617 000 895	Tool Holding Fixture (Chuck)	\$58.00
GBH 2-28 DFV	1 617 000 525	Carbon Brush	\$8.00
	1 617 200 532	On-off Switch	\$25.00
	1 617 000 895	Tool Holding Fixture (Chuck)	\$58.00
GBH 3-28 DFR	1 617 000 525	Carbon Brush	\$8.00
	1 617 200 127	On-off Switch	\$32.50
	1 617 000 895	Tool Holding Fixture (Chuck)	\$58.00
GBH 4-32 DFR	1 614 321 079	carbon Brush Set	\$12.00
	1 617 200 127	On-off Switch	\$32.50
	1 617 000 895	Tool Holding Fixture (Chuck)	\$58.00
GBH 5-40 D	1 617 014 138	Carbon Brush	\$10.00
	1 619 P10 765	Hammer Piston	\$38.00
	1 619 P10 769	Armature	\$65.00
	1 619 P08 323	Field	\$41.00
GBH 8-45 D	1 617 000 A50	Carbon Brush	\$16.00
	1 614 010 267	Armature	\$206.00
	1 614 220 124	Coil	\$44.00
GSH 5 (SDS MAX)	1 617 014 138	Carbon Brush	\$10.00
	1 619 P10 090	Armature	\$156.50
	1 619 P05 386	Field	\$45.00
GSH 5X PLUS	1 617 014 138	Carbon Brush	\$10.00
	1 619 P09 703	Hammer Piston	\$12.50
	1 619 P09 019	Switch	\$12.00
	1 619 P09 697	Armature	\$56.00
	1 619 P08 302	Coil	\$28.00
GSH 5 CE	1 617 014 138	Carbon Brush	\$10.00
	1 614 011 098	Armature	\$175.00
	1 612 300 036	Stopping Device	\$11.00
	1 610 290 076	Indexing Disk	\$7.00
	1 617 000 A00	Hammer Piston	\$22.00
GSH 9 VC	1 617 000 A50	Carbon Brush	\$16.00
	1 614 010 267	Armature	\$206.00
	1 614 220 124	Coil	\$44.00
GSH 11 E	1 617 014 126	Carbon Brush	\$10.00
	1 617 200 048	On-off Switch	\$7.60
	1 607 000 C3V	Coil	\$129.00
GSH 11 VC	1 617 000 A50	Carbon Brush	\$16.00
	1 614 011 120	Armature	\$259.00
	1 604 220 52F	Field	\$82.00
GSH 16-30	1 617 014 126	Carbon Brush	\$10.00
	1 607 000 C3M	Hammer Piston	\$43.00
	1 614 011 117	Armature	\$247.00
	1 607 200 244	Switch	\$38.00
	1 604 220 52M	Field	\$106.00
GSH 27 VC	1 617 000 425	Carbon Brush	\$37.00
	1 614 011 139	Armature	\$478.50

Tool Model	Part No.	Description	Price
GGS 3000 L	1 607 031 223	Carbon Brush	\$2.80
	1 619 P08 203	Armature	\$32.50
	1 607 200 146	On-off Switch	\$12.00
	1 619 P09 835	Field	\$28.00
GGS 5000 L	1 607 031 223	Carbon Brush	\$2.80
	1 619 P08 212	Armature	\$37.50
	1 607 200 146	On-off Switch	\$12.00
	1 619 P09 888	Stator	\$27.50
GGS 28C	1 607 014 176	Carbon Brush	\$7.00
	3 607 030 476	Armature	\$94.50
	1 607 200 199	On-off Switch	\$13.00
	3 607 030 475	Field	\$69.50
GGS 28 LC	1 607 014 176	Carbon Brush	\$7.00
	3 607 030 476	Armature	\$94.50
	1 607 200 199	On-off Switch	\$13.00
	3 607 030 475	Field	\$69.50
GGS 6 S	3 607 014 012	Carbon Brush	\$24.00
	1 604 010 474	Armature	\$223.00
	1 607 200 064	On-off Switch	\$45.00
GWS 060	1 607 031 223	Carbon Brush	\$2.80
	1 619 P01 844	Armature	\$14.00
	1 607 200 179	Switch	\$6.00
	1 619 P12 316	Field	\$9.00
GWS 6-100	1 607 031 223	Carbon Brush	\$2.80
	1 604 010 626	Armature	\$32.00
	1 607 200 179	Switch	\$6.00
	1 604 220 328	Stator	\$25.00
GWS 750-100	1 607 031 223	Carbon Brush	\$2.80
	1 619 P08 234	Armature	\$22.00
	1 619 P08 334	Field	\$19.00
GWS 8-100 C	1 607 031 223	Carbon Brush	\$2.80
	1 604 010 667	Armature With Fan	\$60.00
	1 607 200 179	Switch	\$6.00
	1 607 233 139	Governor	\$59.00
GWS 8-100 CE	1 607 031 223	Carbon Brush	\$2.80
	1 604 010 667	Armature With Fan	\$60.00
	1 607 200 179	Switch	\$6.00
	1 607 233 137	Governor	\$56.00
GWS 900-100	1 619 P10 952	Armature	\$25.00
	1 619 P10 953	Field	\$19.00
	1 607 031 223	Carbon Brush	\$2.80
GWS 8-100 Z	1 607 014 176	Carbon Brush	\$7.00
	1 619 P09 841	Switch	\$11.00
	1 604 010 635	Armature (For 110V)	\$33.00
	1 604 220 306	Field (For 110V)	\$22.00
GWS 12-125 CI	1 607 000 V37	Carbon Brush	\$7.50
	1 607 000 V33	Armature	\$50.00
	1 607 000 448	Bearing Flange	\$20.00
	1 607 233 472	Speed Governor	\$56.00
GWS 13-125 CI	1 607 000 V37	Carbon Brush	\$7.50
	1 607 000 448	Bearing Flange	\$20.00
	1 607 000 V44	Set of Gear	\$28.00

Tool Model	Part No.	Description	Price
GWS 15-125 INOX	1 607 014 176	Carbon Brush	\$7.00
	1 604 010 A23	Armature	\$93.00
	1 607 200 200	On-off Switch	\$12.00
GWS 15-125 CI	1 607 000 V37	Carbon Brush	\$7.50
	1 607 000 V35	Armature	\$107.00
	1 604 220 532	Field Assembly	\$39.00
	1 607 200 256	Switch	\$12.50
GWS 17-125 CI	1 607 000 V37	Carbon Brush	\$7.50
	1 607 000 448	Bearing Flange	\$20.00
	1 600 A00 22W	Gear Set	\$32.00
GWS 17-150 CI	1 607 000 V37	Carbon Brush	\$7.50
	1 607 000 449	Bearing Flange	\$19.50
GWS 20-180	1 607 014 171	Carbon Brush	\$10.00
	1 604 011 252	Armature	\$99.00
	1 604 220 380	Stator	\$47.00
	1 607 000 967	On-off Switch	\$34.00
GWS 20-230	1 607 014 171	Carbon Brush	\$10.00
	1 604 011 252	Armature	\$99.00
	1 604 220 380	Stator	\$47.00
	1 607 000 967	On-off Switch	\$34.00
GDS 18 E	1 619 PA2 438	Carbon Brush Set	\$11.00
	1 619 PA2 453	Tool Holding Fixture	\$181.50
	1 619 PA2 436	Armature	\$90.50
	1 619 PA2 435	Coil	\$69.50
GDS 30	3 607 014 012	Carbon Brush	\$24.00
GRW 12 E	1 607 014 17A	Carbon Brush	\$37.00
	1 604 010 B1U	Armature	\$182.00
	3 609 201 036	Stirner Basket	\$103.00
	1 604 220 23S	Stator	\$93.00
GSC 2.8	2 608 635 065	Upper Blade (GSC2.8)	\$12.00
	2 608 635 042	Lower Blace (GCS2.8)	\$14.00
GNA 2.0	1 607 031 228	Carbon Brush	\$6.20
	2 608 639 900	Lower Die	\$92.60
	2 608 639 013	Curve-Cut Punch	\$30.90
GDM 121	1 619 PA4 025	Carbon Brush Set	\$3.10
	1 619 PA9 243	Armature(GDM121)	\$43.00
	1 619 PA7 561	Switch	\$4.50
	1 619 PA7 559	Field	\$24.00
GDM 13-34	1 619 P06 304	Carbon Brush	\$5.00
	1 619 P06 303	Armature	\$43.50
	1 619 P00 278	Hexagon Screw	\$0.50
	1 619 P07 057	Retaining Washer	\$3.50
	1 619 P06 295	Washer	\$2.50
GKS 7000	1 619 P10 063	Carbon Brush	\$6.00
	1 619 P10 062	Armature	\$49.00
	1 619 P08 314	Coil	\$36.00
	1 619 P09 971	Switch	\$9.00
GST 80 PBE	1 607 031 228	Carbon Brush	\$6.20
	2 601 016 903	Base Plate	\$20.00
	2 601 321 902	Roller Level	\$16.50
	2 600 780 177	Lifting Rod	\$18.50
	2 603 400 000	Headless Screw	\$2.00

Tool Model	Part No.	Description	Price
GSA 1100 E	2 610 956 917	Carbon Brush	\$5.00
	1 619 P05 408	Screw	\$2.00
	1 619 PA4 168	Blade Holder	\$22.00
	2 610 956 898	Supporting Foot	\$13.50
GSA 1300 PCE	2 610 956 917	Carbon Brush	\$5.00
	2 610 010 029	Blade Holder	\$38.00
	2 610 010 015	Supporting Foot	\$32.50
GST 65	2 604 321 919	Carbon Brush	\$6.00
	2 607 200 637	Switch	\$8.00
	2 601 016 012	Base Plate	\$8.00
	2 608 135 901	Retaining Bracket	\$11.00
GST 25 M	1 607 031 228	Carbon Brush	\$6.20
	1 619 P07 199	Base Plate	\$12.50
	1 619 P07 318	Roller Level	\$17.00
GCD 12 JL	1 607 014 171	Carbon Brush	\$10.00
	1 609 B04 679	Armature	\$207.00
	1 609 B00 115	Field	\$75.50
	1 609 B05 400	Switch	\$25.00
GCO 200	1 607 014 171	Carbon Brush	\$10.00
	1 609 B03 639	Armature	\$79.00
	1 609 B00 135	Field	\$54.00
	1 609 B03 606	Switch	\$12.00
GCO 2000	1 607 014 171	Carbon Brush	\$10.00
	1 609 B03 566	Armature	\$94.50
	1 609 B00 129	Field	\$62.00
	1 619 P03 844	On-off Switch	\$19.50
GCO 14-24 J	1 607 014 171	Carbon Brush	\$10.00
	1 609 B03 638	Armature	\$75.00
	1 609 B00 149	Field	\$49.00
GCM 10 S	1 609 203 L02	Carbon Brush	\$15.00
	1 619 P03 776	Rotor	\$147.00
	1 609 203 J56	Coil	\$74.00
GTS 10 J	2 610 018 332	Carbon Brush	\$17.00
	1 609 203 K86	Field	\$59.00
	1 619 P03 278	Armature	\$110.00
GCM 10 M	1 607 014 171	Carbon Brush	\$10.00
	1 609 B00 879	Armature	\$122.50
	1 609 B00 119	Field	\$83.00
	1 609 B00 882	On-off Switch	\$12.50
GCM 10 MX	1 619 PA7 057	Carbon Brush	\$26.50
	1 619 PA7 056	Armature	\$129.00
	1 619 PA6 835	Field	\$86.20
GSG 300	1 607 014 17J	Carbon Brush	\$8.00
	2 608 000 908	Base Plate	\$142.00
	2 607 200 286	On-off Switch	\$9.00
GHO 6500	2 609 110 357	Planning Knife	\$17.50
	2 609 100 410	Toothed Belt	\$5.50
GSS 1400	2 609 120 199	Carbon Brush	\$9.65
	2 609 170 217	Felt	\$7.00
	2 609 101 073	Plate	\$8.00
	2 609 111 796	Clamp Handle	\$2.00
	1 607 200 190	On-off Switch	\$11.00

Tool Model	Part No.	Description	Price
GHO 10-82	1 607 031 222	Carbon Brush	\$5.50
	2 609 110 357	Planning Knife	\$17.50
	2 609 100 410	Toothed Belt	\$5.50
GSS 230	2 609 120 199	Carbon Brush	\$9.65
	2 607 200 632	Switch	\$7.50
	2 609 100 403	Foam Panel	\$14.50
GSS 280 AE	1 607 031 222	Carbon Brush	\$5.50
	2 608 000 168	Sander Plate	\$38.00
	2 607 200 260	Switch	\$8.50
GSS 280 AVE	1 607 031 222	Carbon Brush	\$5.50
GEX 125-1 AE	2 609 120 199	Carbon Brush	\$9.65
	1 607 200 190	On-off Switch	\$11.00
	2 609 199 176	Dust Container	\$25.00
	2 609 100 862	Bearing Flange	\$11.00
	2 609 100 900	Rubber Backing Pad	\$19.50
GBS 75 A	1 607 031 222	Carbon Brush	\$5.50
	2 604 736 010	Toothed Belt	\$10.00
GPO 12 CE	1 607 014 176	Carbon Brush	\$7.00
	1 607 233 256	Speed Goverder	\$107.00
	1 619 P09 841	Switch	\$11.00
	1 619 P09 115	Armature	\$107.00
GBL 800 E	1 604 321 129	Carbon Brush	\$8.00
	1 607 233 348	Speed Goverder	\$25.00
	2 607 200 637	Switch	\$8.00
	1 604 010 A58	Armature	\$57.00
	1 604 220 439	Field	\$58.00
GHG 600-3	1 609 202 617	DC Motor	\$25.00
	1 609 203 H59	Connecting Block	\$32.50
	1 609 203 J91	Heating Element	\$62.00
GHG 630 DCE	1 609 202 611	DC Motor	\$32.00
	1 609 203 L51	Connecting Block	\$135.50
	1 609 203 J99	Heating Element	\$94.50
GMR 1	2 609 120 149	Carbon Brush	\$9.70
	2 609 120 274	On-off Switch	\$14.50
	2 610 008 124	Base Plate	\$8.00
GAS 11-21	2 605 411 150	Dust Bag	\$45.10
	1 609 203 A54	Filter	\$12.50
	1 609 203 A55	Support Frame	\$6.00
	1 609 203 A53	Retaining Ring	\$5.50
	1 609 203 A33	On-off Switch	\$8.50
	1 609 203 D28	Container	\$65.00
	2 607 002 149	Hose for 35 x 3000	\$35.20
	1 609 203 B92	Suction Pipe	\$16.50
1 609 390 478	Suction Nozzle	\$54.90	
GLL 3-15 X	1 618 C01 11X	Turntable	\$25.00
GLL 5-50 X	1 618 C01 11X	Turntable	\$25.00
AQT 33-11			
	F 016 F04 796	Trigger	\$16.00
	F 016 800 360	High Pressure Hose (6m)	\$27.20
	F 016 800 361	Extension Hose (6m)	\$24.50
	F 016 F05 017	Lance	\$12.00
	F 016 800 352	3 IN 1 Nozzle	\$27.20

Tool Model	Part No.	Description	Price
EASYAQUATAK	F 016 F04 796	Trigger	\$16.00
	F 016 800 360	High Pressure Hose (6m)	\$27.20
	F 016 F05 017	Lance	\$12.00
AQT 45-14 X	F 016 F04 633	Trigger	\$36.00
	F 016 F04 667	Hose (8m)	\$39.00
	F 016 F05 017	Lance	\$12.00
	F 016 800 352	3 IN 1 Nozzle	\$27.20
GHP 5-13 C	F 016 L72 097	Handle	\$56.00
	F 016 L72 098	Jet Pipe	\$40.00
	F 016 F04 523	Hose (9m)	\$90.00
GHP 5-55	F 016 L73 068	Handle	\$39.00
	F 016 L73 069	Jet Pipe	\$39.00
	F 016 F04 523	Hose (9m)	\$90.00
GHP 5-65	F 016 L73 068	Handle	\$39.00
	F 016 L73 069	Jet Pipe	\$39.00
	F 016 F04 523	Hose (9m)	\$90.00
GHP 5-75	F 016 L73 068	Handle	\$39.00
	F 016 L73 069	Jet Pipe	\$39.00
	F 016 F04 523	Hose (9m)	\$90.00
GHP 6-14	F 016 L72 097	Handle	\$56.00
	F 016 L72 179	Jet Pipe	\$69.50
	F 016 F04 523	Hose (9m)	\$90.00

WARRANTY

This serves to inform all Bosch Power Tools are guaranteed against manufacturing defects for a period of 6 months from the registered date of purchase **(except Bosch Measuring Tools which are guaranteed for a period of 12 months)**.

This guarantee, however, does not cover damage caused by accident, misuse, unauthorised repairs, tampering, additions and modifications made to the tool in any manner.

In case of complaint, please send the tool, undismantled and with proof of purchase by invoice or receipt of payment to **Bosch Power Tools Authorised Service Centre (Tel: 6746 9770)**.

保证

谨此通知阁下有关所有博世电动工具享有为期六个月之生产损坏保证,有效期从购买登记日算起。(除了博世电子测量器享有为期十二个月生产损坏证)。

无论如何,上述保证并不包括有关电动工具因意外, 错误使用、非授权维修、附加及修换或其他方式所造成的损坏及故障。若有任何投诉, 请将阁下完整的电动工具和购买发票或付款收据交到您的**博世电动工具授权服务中心(电话:6746 9770)**。



Authorised Service Centre

Powerwell Service Centre Pte Ltd
4012 Ang Mo Kio Ave 10,
#01-02 Techplace 1, Singapore 569628
Tel: (65) 6452 1770
Fax: (65) 6452 1760
Email: ask@powerwellsc.com

Robert Bosch (SEA) Pte Ltd

11 Bishan Street 21,
Singapore 573943
Tel: (65) 6571 2772
Fax: (65) 6571 2784
www.bosch-pt.com.sg

For further enquiries, please contact



1 800 333 8 333

Mon - Fri: 8.30am - 5.30pm

Authorised Service Centre:

Powerwell Service Centre Pte Ltd

4012 Ang Mo Kio Ave 10,
#01-02 Techplace 1, Singapore 569628
Tel: (65) 6452 1770
Fax: (65) 6452 1760
Email: ask@powerwellsc.com

While all care has been taken to ensure that the information contained in this publication is correct, no responsibility can be accepted for any inaccuracy. The Company reserves the right to alter or modify the information contained herein at any time in light of technical or other developments. Technical specifications are valid under normal operating conditions only. The company does not accept any responsibility for any misuse of the product and cannot be held liable for consequential damage.